

Industrial Chassis

• [Rack Mount Chassis >>](#)

• [Compact Chassis >>](#)

• [Embedded Chassis >>](#)

Chassis Selection Guide

Model No.	Type	Board Type		Max. slots	Drive Capacity				Fan Spec.			
		Slot SBC	Motherboard		5.25" F.P.	3.5" F.P.	2.5" Int	3.5" Int	4cm	6cm	8cm	12cm
RACK-1150G	1U	full-size		3	1			1	3			
RACK-1151G	1U	full-size		3	1			1	3			
RACK-220G	2U	full-size		6	1	1		1			2	
RACK-2000G	2U	full-size		6	1	1		1			2	
RACK-1350G	3U		ATX, Micro-ATX, Mini-ITX	7	2	1		1		**2	2	
RACK-3400G	4U	half-size		10	2	1					2	
RACK-305G	4U	full-size	*ATX, Micro-ATX, Mini-ITX	14	2	1		1		***2	2	
RACK-360G	4U	full-size	*ATX, Micro-ATX, Mini-ITX	14	2	1		1		***2		1
RACK-814G	4U	full-size		14	1	1		1			3	
RACK-3000G	4U	full-size	*ATX, Micro-ATX, Mini-ITX	14	3	2		1		***2	2	
RACK-3200G	4U	full-size		20	+6	1					4	
RACK-500G	5U	full-size		5		1		1			1	
RACK-900G	5U	full-size		10	1	1		1	**1		2	
RACK-3035G	7U	full-size		20	+6						5	
PAC-42GF		full-size		4		1	▲2				1	
PAC-1000G		full-size		6	1	1		1			1	
PAC-106G		full-size		6		1		1			1	
PAC-107G		full-size		6	1	1		1			1	
PAC-1700G		full-size		7	1	1		2			1	
PAC-125G		full-size		10	2	1		1			1	
PAC-53GH		half-size		3			1					
PR-1300G		half-size		3		1				1		
PAC-42GH		half-size		4		△1				△1	1	
PR-1500G		half-size		5	◇1	1		1			1	
PAC-400G		half-size		5				△1			1	
PAC-52G		half-size		6								
PAC-700G		half-size		7	1	△1		1			1	
EBC-1000G			WAFER Series				1		1			
EBC-2100			NANO Series				1		**1			

■ Rackmount chassis
■ Full-size wall mount chassis
■ Half-size wall mount chassis
■ Embedded chassis

* for ATX model
 ** optional
 *** optional fans for ATX model

◇ slim-type CD-ROM
 △ Please refer to datasheet for detail information
 † Each 5.25" space can be changed to 3.5"(F.P. or HDD) with optional bracket
 ▲ PAC-42GF can accommodate 2 x 2.5"HDD or 2 x 3.5" HDD

Chassis Selection Guide

Indicators		Front Panel Control					PSU	Dimensions(mm)			Color		
Power	HDD	Power	reset	KB connector	USB	keylock		Depth	Height	Width	Black	White	Other
x	x	x	x		2		1U	449	44	431	x		
x	x	x	x		2		1U	440	44	431	x		
x	x	x	x		2	x	PS/2	487.5	88	431	x	x	
x	x	x	x			x	PS/2	576.9	88	431	x	x	
x	x	x	x		2	x	2U	480	133	431	x		
x	x	x	x			x	PS/2 or mini redundant	283	176	431	x	x	
x	x	x	x	x	2	x	PS/2 or mini redundant	413	176	431	x	x	
x	x	x	x	x	2	x	PS/2 or mini redundant	435.5	176	431	x	x	
x	x	x	x		2	x	PS/2 or mini redundant	454.7	176	431	x		
x	x	x	x			x	PS/2 or mini redundant	520	176	431	x	x	
x	x	x	x			x	PS/2 or mini redundant	674	176	431	x	x	
x	x	x	x		2		1U	440.2	221.3	110.6	x	x	
x	x	x	x		2		1U	440.2	221	221	x		
x	x	x	x		2	x	2 x PS/2 redundant	504	311	431	x		
x	x	x	x		2		1U	405	200	140		x	
x	x	x	x				PS/2	421	176	232	x		
x	x	x	x		2		1U	400	175.5	166		x	
x	x	x	x		2		1U	400	218.5	166		x	
x	x	x	x				PS/2	433	253.7	192.4	x		
x	x	x	x		2	x	PS/2	420	176	321		x	
x	x	x	x		2		1U	218	200	95		x	
x	x	x	x		2		1U	254	88	265		x	
x	x	x	x		2		1U	269	230	140		x	
x	x	x	x		2		1U	254	132	286		x	
x	x	x	x		2		1U	269	230.5	140		x	
x			x		1		N/A	218	147	152.2		x	
x	x	x	x		2	x	1U	279	176	321	x		
x	x	x	x				ACE-890 Series open frame	130	116	172.2	x		
		x					12VDC power adaptor	134	56	262			Gray

RACK-1150G

1U 3-slot Full-size Rackmount Chassis

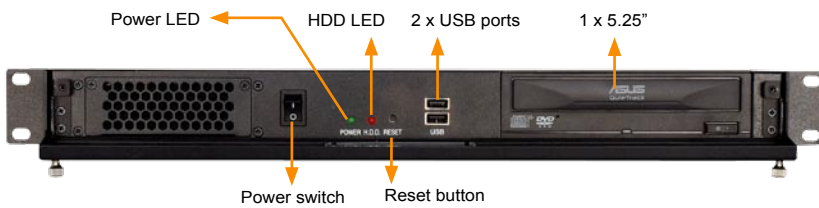

CD-ROM, and HDD are not included in package.

Features

- ◆ RoHS compliant design
- ◆ 2 x front-accessible USB ports
- ◆ 1 x 5.25" and 1 x 3.5" HDD drive capacity
- ◆ 3 x 4 cm cooling fans

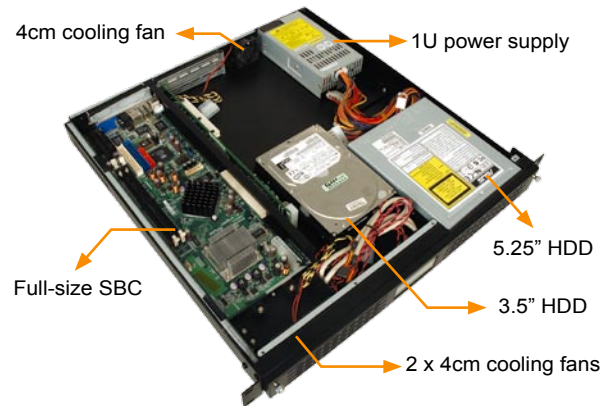

Specifications

◆ Construction	Heavy duty metal
◆ SBC Form Factor	Full-size, slot CPU card
◆ Drive Bays	1 x 5.25" 1 x 3.5" HDD
◆ Cooling Fans	3 x 4 cm
◆ I/O Ports	2 x USB
◆ I/O openings	1 x COM, 1 x LPT
◆ Expansion Slots	3 slots
◆ Indicators	Power, HDD
◆ Buttons	Power switch, reset
◆ Operating Temperature	0~50°C
◆ Operation Humidity	10% ~ 90%
◆ Color	B: Black
◆ Weight (Net/Gross)	7.5kg / 9.5kg
◆ Dimensions (DxWxH)	449mm x 431mm x 44mm

Dimensions

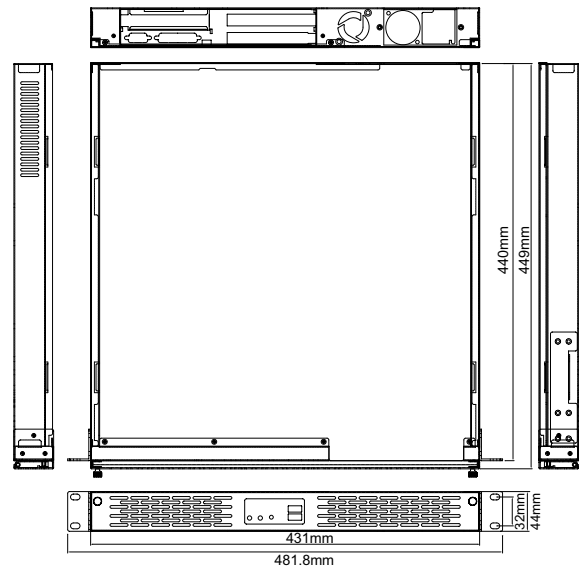

Backplane Options

Model No.	SBC Interface	PCI	ISA	PSU Connector
PCI-2SD2-RS-R30	PICMG 1.0	2	0	ATX

Power Supply Options

Type	Model No.	Watt
ATX	ACE-816AP-RS	150W
	ACE-4518AP-RS	180W
	ACE-4525AP-RS	250W

RACK-1150G can support single 1U height PSU, for more models of IEI PSU, please visit www.ieiworld.com

Ordering Information

Part No.	Description
RACK-1150GB/ACE-816AP/PCI-2SD2	1U 3-slot full-size rackmount chassis, black, ACE-816AP-RS and PCI-2SD2-RS-R30, RoHS

RACK-1151G

1U 3-slot Full-size Rackmount Chassis



Features

- ◆ RoHS compliant design
- ◆ 2 x front-accessible USB ports
- ◆ 1 x 5.25" and 1 x 3.5" HDD drive capacity
- ◆ 3 x 4 cm cooling fans
- ◆ LCD message module on front panel

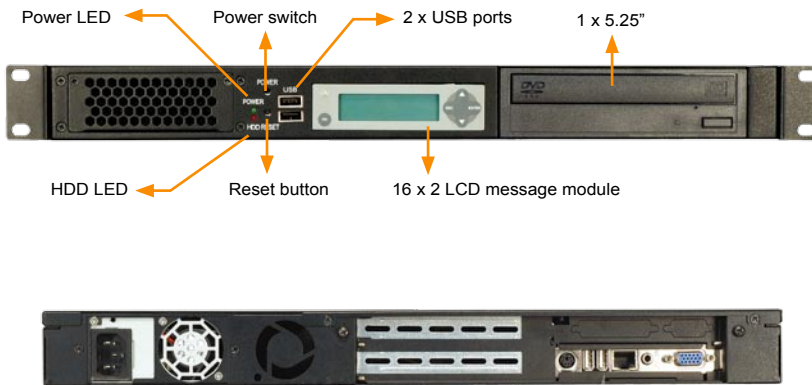

CD-ROM and HDD are not included in package.

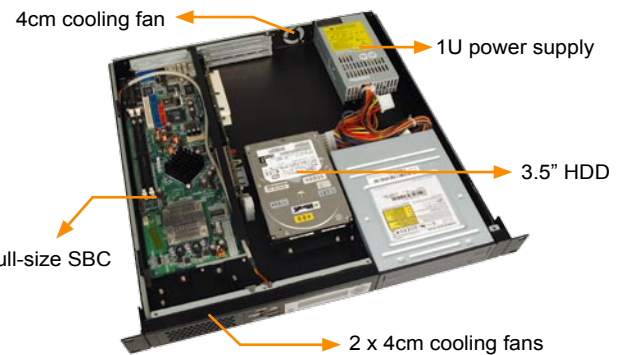

Specifications

◆ Construction	Heavy duty metal
◆ SBC Form Factor	Full-size, slot CPU card
◆ Drive Bays	1 x 5.25" 1 x 3.5" HDD
◆ Cooling Fans	3 x 4 cm
◆ I/O Ports	2 x USB
◆ I/O openings	1 x COM, 1 x LPT
◆ Expansion Slots	3 slots
◆ Indicators	Power, HDD
◆ Buttons	Power switch, reset
◆ LCD module	16x2 programmable LCD message module (LCM-02G)
◆ Operating Temperature	0~50°C
◆ Operation Humidity	10% ~ 90%
◆ Color	B: Black
◆ Weight (Net/Gross)	7kg / 9kg
◆ Dimensions (DxWxH)	440mm x 431mm x 44mm

Dimensions

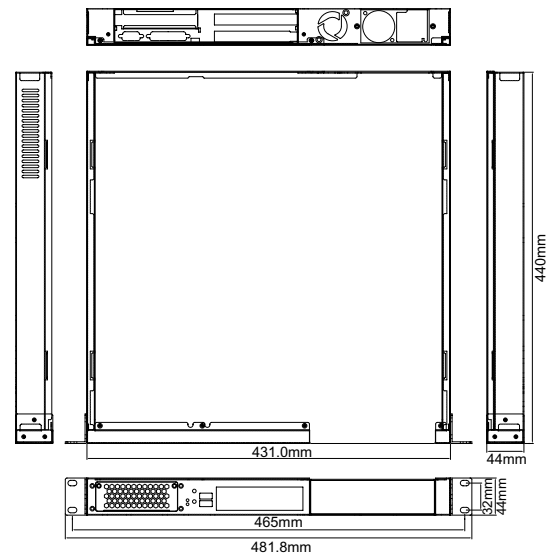

Backplane Options

Model No.	SBC Interface	PCI	ISA	PSU Connector
PCI-2SD2-RS-R30	PICMG 1.0	2	0	ATX

Power Supply Options

Type	Model No.	Watt
ATX	ACE-816AP-RS	150W
	ACE-4518AP-RS	180W
	ACE-4525AP-RS	250W

RACK-1151G can support single 1U height PSU, for more models of IEI PSU, please visit www.ieiworld.com

Ordering Information

Part No.	Description
RACK-1151GB/ACE-816AP/PCI-2SD2	1U 3-slot full-size rackmount chassis, black, with LCM-02G, ACE-816AP-RS and PCI-2SD2-RS-R30, RoHS

RACK-220G

2U 6-slot Full-size Rackmount Chassis

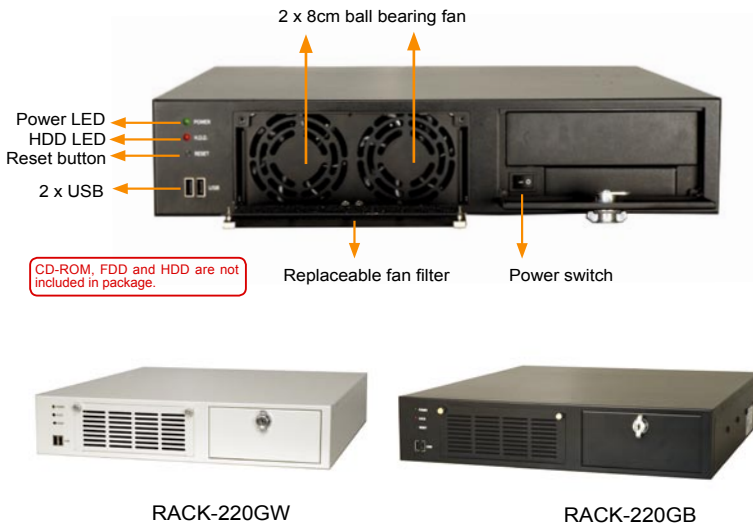

Features

- ◆ RoHS compliant design
- ◆ 2 x USB on front panel
- ◆ 2 x 8cm cooling fans with easy replaceable fan filter
- ◆ 1 x 5.25", 1 x front accessible 3.5", 1 x 3.5" HDD

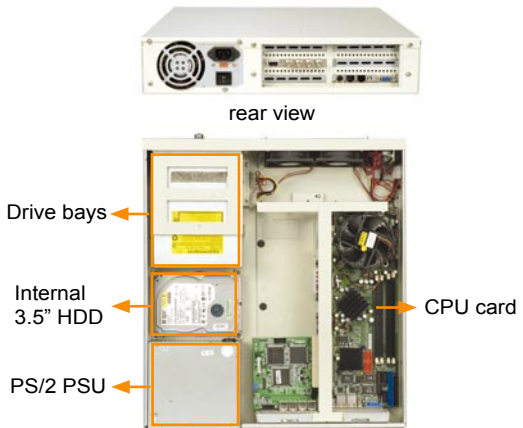

Dimensions

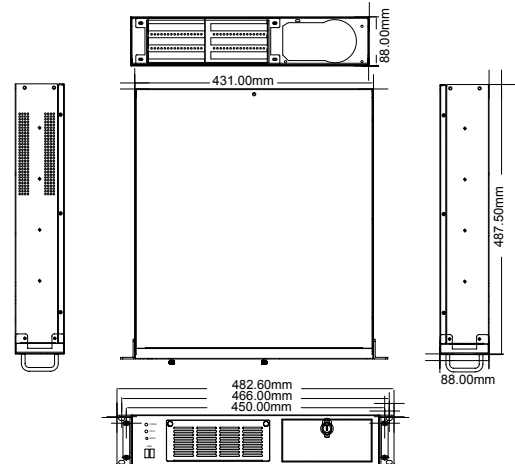

Specifications

◆ Construction	Heavy duty metal
◆ SBC Form Factor	Full-size, slot CPU card
◆ Drive Bays	1 x 5.25"
	1 x front accessible 3.5"
◆ Cooling Fans	1 x 3.5" HDD
	2 x 8cm
◆ I/O Ports	2 x USB
◆ Expansion Slots	6 slots
◆ Indicators	Power, HDD
◆ Buttons	Power switch, reset
◆ Operating Temperature	0~50°C
◆ Operation Humidity	10% ~ 90%
◆ Color	W:White / B:Black
◆ Weight (Net/ Gross)	8.2 kg / 12.4 kg
◆ Dimensions (DxWxH)	487.5mm x 431mm x 88 mm

Backplane Options

Model No.	SBC Type	PCI	ISA	PCIe			PSU Connector
				x1	x4	x16	
PCI-5SDA-RS-R30	PICMG 1.0	L2+R2	0	0	0	0	AT/ATX
PCI-5SD5-RS-R30	PICMG 1.0	L2+R2	0	0	0	0	AT
PCIAGP-5SD-RS-R30	PIAGP	L2+R1	0	0	0	0	ATX
PCI-6SD-RS-R30	PICMG 1.0	L1+R1	L1+R1	0	0	0	ATX
PE-6SD	PICMG 1.3	0	0	3	0	1	ATX
PE-6SD2	PICMG 1.3	1	0	2	0	1	ATX

Power Supply Options

Type	Model No.	Watt
AT	ACE-925AP-U-RS	250W
	ACE-935AL-RS	300W
ATX	ACE-832AP-RS	300W
	ACE-841AP-S-RS	400W

RACK-220G can support single PS/2 PSU. For more models of IEI, please visit www.ieiworld.com

Ordering Information

Part No.	Description
RACK-220G □ /ACE-832AP	2U 6-slot full-size rackmount chassis, with ACE-832AP-RS, RoHS

□ Color Code: B-Black W-White

RACK-2000G

2U 6-slot Full-size Rackmount Chassis



Features

- ◆ RoHS compliant design
- ◆ Stylish front panel with keylock
- ◆ 1 x 3.5" FDD, 1 x 5.25", 1 x 3.5" HDD drive capacity
- ◆ 2 x 8cm cooling fans with easy replaceable fan filter

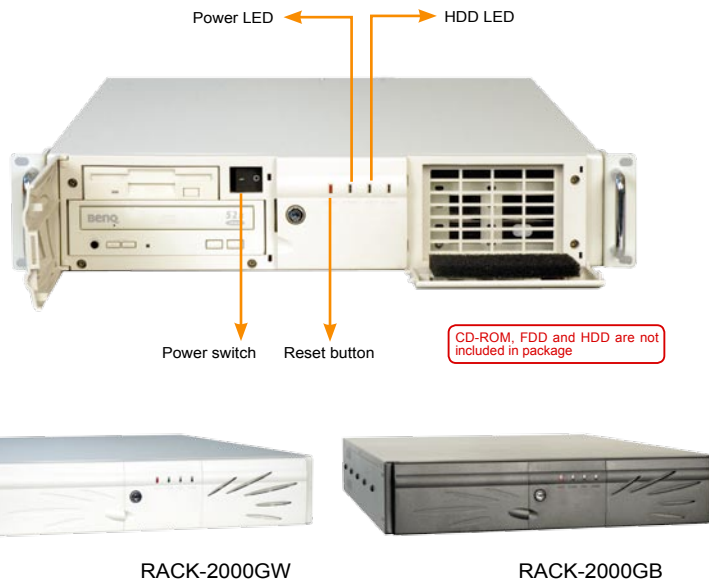

Dimensions

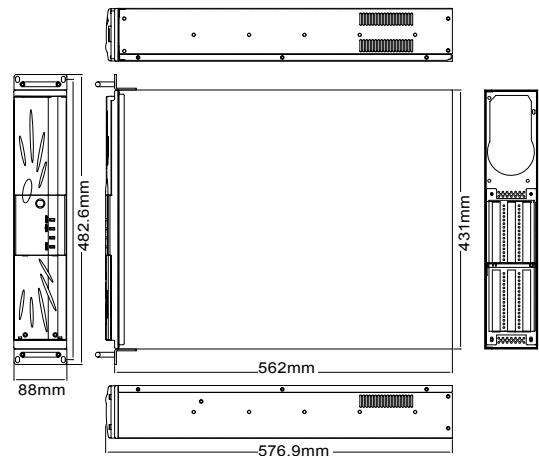

Backplane Options

Model No.	SBC Type	PCI	ISA	PCIe			PSU Connector
				x1	x4	x16	
PCI-5SDA-RS-R30	PICMG 1.0	L2+R2	0	0	0	0	AT/ATX
PCI-5SD5-RS-R30	PICMG 1.0	L2+R2	0	0	0	0	AT
PCIAGP-5SD-RS-R30	PIAGP	0	L2+R2	0	0	0	ATX
PCI-6SD-RS-R30	PICMG 1.0	L1+R1	L1+R1	0	0	0	ATX
PE-6SD	PICMG 1.3	0	0	3	0	1	ATX
PE-6SD2	PICMG 1.3	1	0	2	0	1	ATX

Power Supply Options

Type	Model No.	Watt
AT	ACE-925AP-U-RS	250W
	ACE-935AL-RS	300W
ATX	ACE-832AP-RS	300W
	ACE-841AP-S-RS	400W
ATX Redundant	ACE-R4130AP-RS	300W

RACK-2000G can support single PS/2 PSU. For more models of IEI PSU, please visit www.ieiworld.com

Specifications

◆ Construction	Heavy duty metal with plastic front panel
◆ SBC Form Factor	Full-size, slot CPU card
◆ Drive Bays	1 x front accessible 3.5"
	1 x 3.5" HDD
	1 x 5.25"
◆ Cooling Fans	2 x 8 cm
◆ Expansion Slots	6 slots
◆ Indicators	Power, HDD
◆ Buttons	Power switch, reset
◆ Operating Temperature	0~50°C
◆ Operation Humidity	10% ~ 90%
◆ Color	W: White / B: Black
◆ Weight (Net/Gross)	7.8kg / 11.8kg
◆ Dimensions (DxWxH)	576.9mm x 431mm x 88mm

Ordering Information

Part No.	Description
RACK-2000G ☐ /ACE-832AP	2U 6-slot full-size rackmount chassis, with ACE-832AP-RS, RoHS

☐ Color Code: B-Black W-White

RACK-1350G

3U Rack-mount Chassis for Motherboard

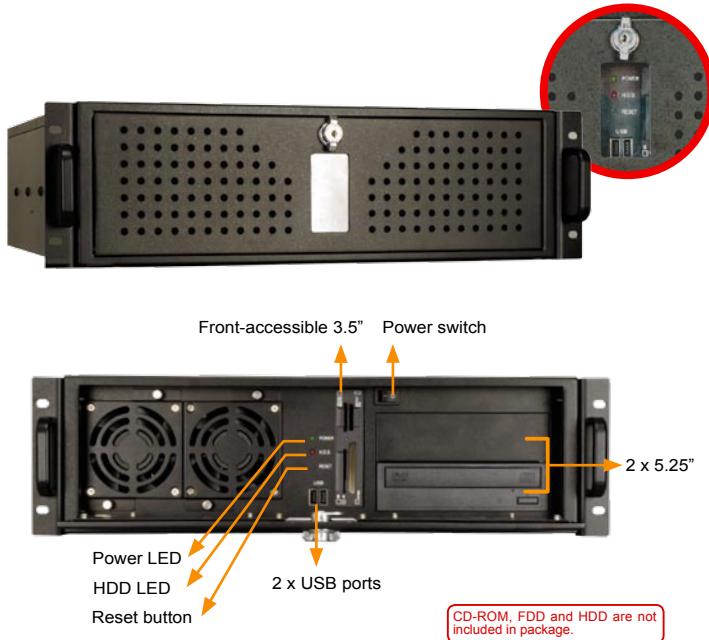

CD-ROM, FDD and HDD are not included in package.

Features

- ◆ RoHS compliant design
- ◆ Compatible with ATX, MicroATX and Mini-ITX form factor motherboard
- ◆ Up to seven expansion slots
- ◆ 2 x 8 cm cooling fans



ATX form factor



Mini-ITX form factor



Micro ATX form factor

Dimensions

measurement units: millimeter

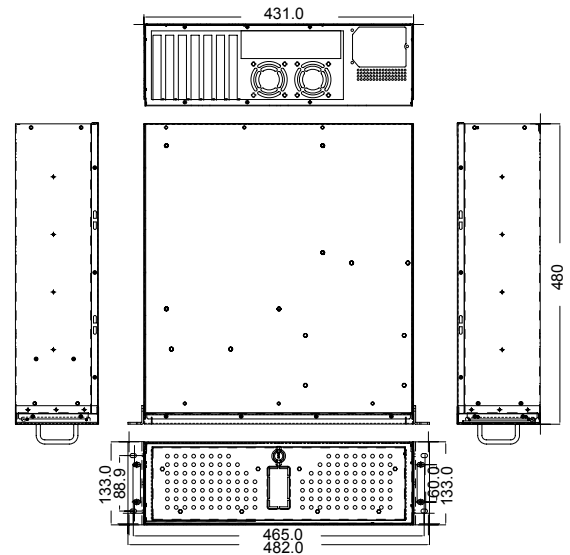

Specifications

◆ Construction	Heavy duty metal
◆ SBC Form Factor	ATX, Micro ATX, Mini-ITX motherboard
◆ Drive Bays	2 x 5.25" 1 x front-accessible 3.5" 1 x 3.5" HDD
◆ Cooling Fans	2 x 8 cm + 2 x 6cm (optional)
◆ I/O Ports	2 x USB
◆ I/O openings	2 x COM, 2 x LPT, 1 x PS2
◆ Expansion Slots	7 slots
◆ Indicators	Power, HDD
◆ Buttons	Power switch, reset
◆ Operating Temperature	0~50°C
◆ Operation Humidity	10% ~ 90%
◆ Color	B: Black
◆ Weight (Net/Gross)	10.4kg / 15kg
◆ Dimensions (DxWxH)	480mm x 431mm x 133mm

* RACK-1350G supports 5.25" drive with depth up to 185mm.

Ordering Information

Part No.	Description
RACK-1350GB/ACE-4530AP	3U Rackmount chassis for ATX, Micro ATX and Mini ITX motherboard, black, with ACE-4530AP-RS, RoHS

Motherboard Options

Form Factor	Model No.	PSU Connector
ATX	IMBA-8650	ATX
Micro ATX	IMB-8550	ATX
	IMB-9454	ATX
	IMB-9452	ATX
	IMB-9154	ATX
Mini-ITX	KINO-6612	ATX
	KINO-LX	ATX
	A-200	ATX
	KINO-LUKE	ATX
	KINO-MARK	ATX
	KINO-9452	ATX
	KINO-9454	ATX
	KINO-6614	ATX

Power Supply Options

Type	Model No.	Watt
ATX	ACE-4525AP-RS	250W
	ACE-4530AP-RS	300W

RACK-3400G

4U 10-slot Half-size Rackmount Chassis

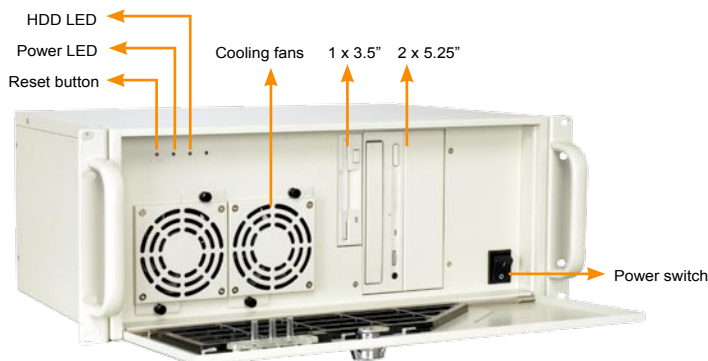

CD-ROM, FDD and HDD are not included in package



Features

- ◆ RoHS compliance
- ◆ Design for half-size CPU Card
- ◆ 2 x 5.25" and 1 x 3.5" FDD drive capacity
- ◆ 2 x 8 cm hot replaceable cooling fans

Hot-replaceable cooling fan



Step 1:
Loose the thumb screws



Step 2:
Pull the fan out gently



Step 3:
Unplug the power connector



RACK-3400GW



RACK-3400GB

Dimensions

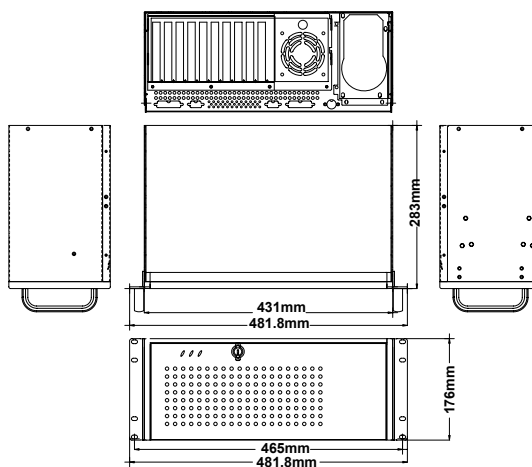

Specifications

◆ Construction	Heavy duty metal
◆ SBC Form Factor	Half-size, slot CPU card
◆ Drive Bays	1 x front-accessible 3.5" 2 x 5.25"
◆ Cooling Fans	2 x 8 cm
◆ I/O Openings	2 x COM, 2 x LPT, 1 x PS/2
◆ Expansion Slots	10 slots
◆ Indicators	Power, HDD
◆ Buttons	Power switch, reset
◆ Operating Temperature	0~50°C
◆ Operation Humidity	10% ~ 90%
◆ Color	W: White / B: Black
◆ Weight (Net/Gross)	8kg / 11.2kg
◆ Dimensions (DxWxH)	283mm x 431mm x 176mm

Ordering Information

Part No.	Description
RACK-3400G [C] /ACE-832AP	4U 10-slot half-size Rackmount chassis, with ACE-832AP-RS, RoHS

[C] Color Code: B-Black W-White

Backplane Options

Model No.	SBC Type	PCI	ISA	PCIe			PSU Connector
				x1	x4	x16	
BP-10S-RS-R30	ISA	0	10	0	0	0	AT
IP-10S-RS-R30	PCISA	4	5	0	0	0	AT/ATX
IPX-9S-RS-R30	PCISA	8	0	0	0	0	AT/ATX
HPE-7S1	PCI/PICoE	4	0	2	0	0	ATX
HPE-8S0	PCI/PICoE	4	0	2	0	0	ATX

Power Supply Options

Type	Model No.	Watt
AT	ACE-925AP-U-RS	250W
	ACE-935AL-RS	300W
	ACE-940AP-RS	390W
ATX	ACE-832AP-RS	300W
	ACE-841AP-S-RS	400W
	ACE-850AP-RS	500W
ATX Redundant	ACE-R4130AP-RS	300W

RACK-3400G can support single PS/2 PSU. For more models of IEI PSU, please visit www.ieiworld.com

RACK-305G

4U 14-slot Full-size Rackmount Chassis

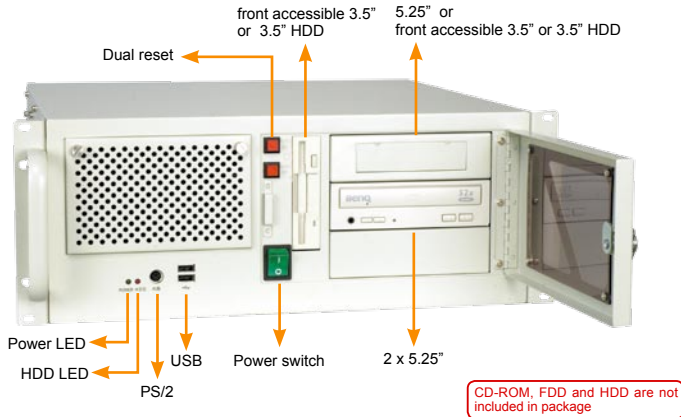

RACK-305GW



RACK-305GB

Features

- ◆ RoHS compliant design
- ◆ USB x 2 & PS2 for KBD on front panel
- ◆ Dual reset buttons for dual systems
- ◆ 2 x 8 cm cooling fan with replaceable fan filter

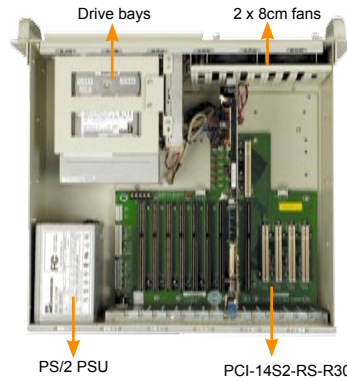

Dimensions

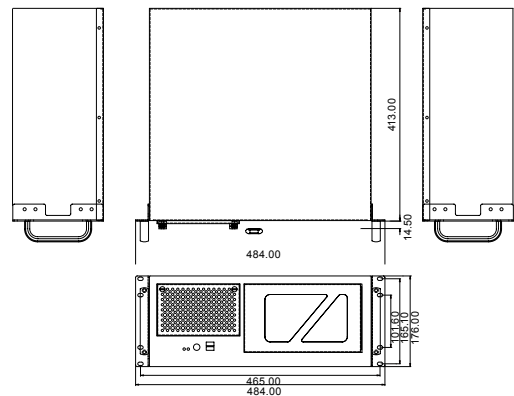

Specifications

◆ Construction	Heavy duty metal
◆ SBC Form Factor	Full-size, slot CPU card
◆ Drive Combinations	3 x 5.25" + 1 x 3.5" HDD
	or 2 x 5.25" + 2 x 3.5" HDD
	or 2 x 5.25" + 1 x 3.5" HDD + 1 x front accessible 3.5"
	or 2 x 5.25" + 2 x front accessible 3.5"
◆ Cooling Fans	2 x 8 cm
◆ I/O Ports	2 x USB, 1 x PS2
◆ Expansion Slots	14 slots for RACK-305G 7 slots for RACK-305GATX
◆ Indicators	Power, HDD
◆ Buttons	1 x power switch, 2 x reset
◆ Operating Temperature	0~50°C
◆ Operation Humidity	10% ~ 90%
◆ Color	W: White / B: Black
◆ Weight (Net/ Gross)	10.4 kg / 15kg
◆ Dimension (DxWxH)	413mm x 431mm x 176mm

Ordering Information

Part No.	Description
RACK-305G [C] / ACE-935AL	4U 14-slot rackmount chassis, with ACE-935AL-RS, RoHS
RACK-305G [C] ATX/ ACE-832AP	4U ATX MB rackmount chassis, with ACE-832AP-RS, RoHS

[C] Color Code: B-Black W-White

Backplane Options

Model No.	SBC Type	PCI	ISA	PCIe			PSU Connector
				x1	x4	x16	
PCI-13SD-RS-R30	PICMG 1.0	3+4	3+3	0	0	0	AT/ATX
PCI-14S2-RS-R30	PICMG 1.0	4	8	0	0	0	AT/ATX
PCI-14S3-RS-R30	PICMG 1.0	4	9	0	0	0	AT/ATX
PX-14S3-RS-R30	PICMG 1.0	12	2	0	0	0	AT/ATX
PX-14S5-RS-R30	PICMG 1.0	7	6	0	0	0	AT/ATX
BP-14S-RS-R30	ISA	0	14	0	0	0	AT
PXAGP-13S3-RS-R30	PIAGP	11	0	0	0	0	AT/ATX
PE-6S	PICMG 1.3	2	0	1	1	1	ATX
PE-10S	PICMG 1.3	4	0	3	1	1	ATX
PE-10S2	PICMG 1.3	4	0	4	0	1	ATX
PE-13SD	PICMG 1.3	4	0	5	0	2	ATX
PXE-13S	PICMG 1.3	8	0	3	0	1	ATX
PXE-13S2	PICMG 1.3	4	0	7	0	1	ATX
PXE-13S3	PICMG 1.3	3	0	0	8	1	ATX

Power Supply Options

Type	Model No.	Watt
AT	ACE-935AL-RS	300W
	ACE-940AP-RS	390W
ATX	ACE-841AP-S-RS	400W
	ACE-850AP-RS	500W
	ACE-4860AP-RS	600W
ATX Redundant	ACE-R4130AP-RS	300W

RACK-305G can support single PS/2 PSU. For more models of IEI PSU, please visit www.ieiworld.com

RACK-360G

4U 14-slot Full-size Rackmount Chassis

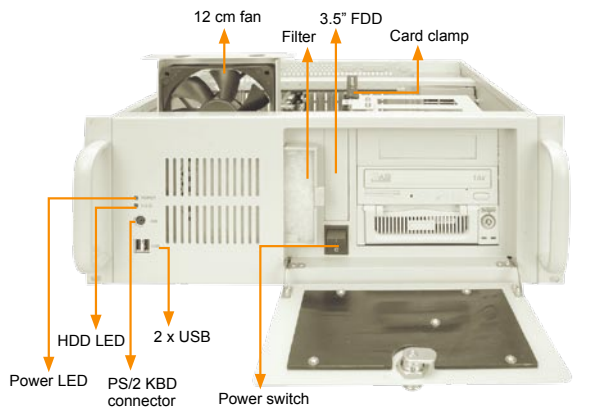

CD-ROM, FDD and HDD are not included in package

space for: front accessible 3.5" or 3.5" HDD

space for: 5.25" or front accessible 3.5" or 3.5" HDD



Flexible drive combination

Features

- ◆ Cost effective, RoHS compatible design
- ◆ Flexible drive combination
- ◆ USB x 2 & PS2 on front panel for easy accessibility
- ◆ 12cm cooling fan with replaceable fan filter
- ◆ Lockable front door prevents unauthorized access



RACK-360GW



RACK-360GB



Replaceable Fan Filter



Front accessible I/O

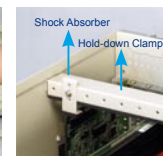

Anti-vibration Card Clamp

Dimensions

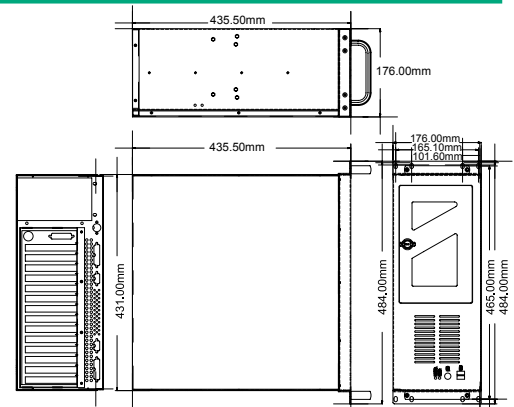

Backplane Options

Model No.	SBC Type	PCI	ISA	PCIe			PSU Connector
				x1	x4	x16	
PCI-13SD-RS-R30	PICMG 1.0	3+4	3+3	0	0	0	AT/ATX
PCI-14S2-RS-R30	PICMG 1.0	4	8	0	0	0	AT/ATX
PCI-14S3-RS-R30	PICMG 1.0	4	9	0	0	0	AT/ATX
PX-14S3-RS-R30	PICMG 1.0	12	2	0	0	0	AT/ATX
PX-14S5-RS-R30	PICMG 1.0	7	6	0	0	0	AT/ATX
BP-14S-RS-R30	ISA	0	14	0	0	0	AT
PXAGP-13S3-RS-R30	PIAGP	11	0	0	0	0	AT/ATX
PE-6S	PICMG 1.3	2	0	1	1	1	ATX
PE-10S	PICMG 1.3	4	0	3	1	1	ATX
PE-10S2	PICMG 1.3	4	0	4	0	1	ATX
PE-13SD	PICMG 1.3	4	0	5	0	2	ATX
PXE-13S	PICMG 1.3	8	0	3	0	1	ATX
PXE-13S2	PICMG 1.3	4	0	7	0	1	ATX
PXE-13S3	PICMG 1.3	3	0	0	8	1	ATX

Power Supply Options

Type	Model No.	Watt
AT	ACE-935AL-RS	300W
	ACE-940AP-RS	390W
	ACE-841AP-S-RS	400W
ATX	ACE-850AP-RS	500W
	ACE-4860AP-RS	600W
	ACE-R4130AP-RS	300W
ATX Reduandant	ACE-R4130AP-RS	300W

RACK-360G can support single PS/2 PSU. For more models of IEI PSU, please visit www.ieiworld.com

Specifications

◆ Construction	Heavy duty metal
◆ SBC Form Factor	Full-size, slot CPU card
◆ Drive Combinations	3 x 5.25" + 1 x 3.5" HDD
	or 2 x 5.25" + 2 x 3.5" HDD
	or 2 x 5.25" + 1 x 3.5" HDD + 1 x front accessible 3.5"
	or 2 x 5.25" + 2 x front accessible 3.5"
◆ Cooling Fans	1 x 12cm
◆ I/O Ports	2 x USB, 1 x PS/2
◆ I/O Openings	2 x COM, 2 x LPT, 1 x PS/2
◆ Expansion Slots	14 slots for RACK-360G 7 slots for RACK-360GATX
◆ Indicators	Power, HDD
◆ Buttons	Power switch, reset
◆ Operating Temperature	0~50°C
◆ Operation Humidity	10% ~ 90%
◆ Color	B: Black / W: White
◆ Weight (Net/ Gross)	11 kg / 15.4 kg
◆ Dimension (DxWxH)	435.5mm x 431mm x 176 mm

Ordering Information

Part No.	Description
RACK-360G /ACE-935AL	4U 14-slot rackmount chassis, with ACE-935AL-RS, RoHS
RACK-360G ATX/ACE-832AP	4U ATX MB rackmount chassis, with ACE-832AP-RS, RoHS

Color Code: B-Black W-White

RACK-814G

4U 14-slot Full-size Rackmount Chassis

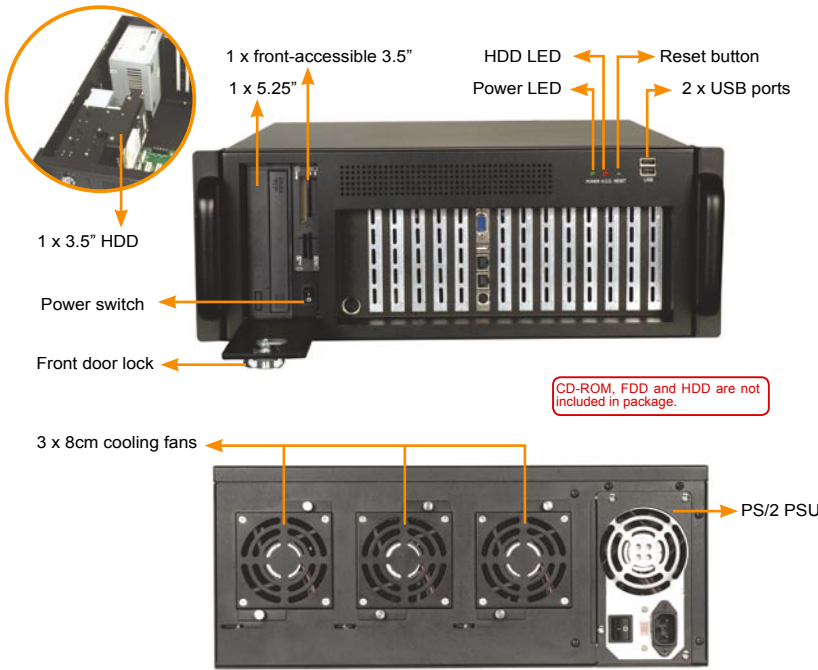

Features

- ◆ RoHS compliance
- ◆ 2 x USB ports on front panel
- ◆ 3 x hot-replaceable 8 cm cooling fans
- ◆ Front-accessible I/O slots

Dimensions

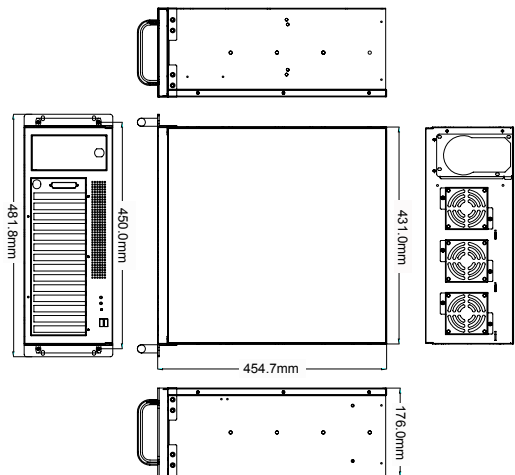

Specifications

◆ Construction	Heavy duty metal
◆ SBC Form Factor	Full-size, slot CPU card
◆ Drive Bays	1 x 5.25"
	1 x front accessible 3.5"
	1 x 3.5" HDD
◆ Cooling Fans	3 x 8 cm
◆ I/O ports	2 x USB
◆ Expansion Slots	14 slots
◆ Indicators	Power, HDD
◆ Buttons	Power switch, reset
◆ Operating Temperature	0~50°C
◆ Operation Humidity	10% ~ 90%
◆ Color	B: Black
◆ Weight (Net/Gross)	10.4kg / 15kg
◆ Dimensions (DxWxH)	454.7mm x 431mm x 176mm

Ordering Information

Part No.	Description
RACK-814GB/ACE-935AL	4U 14-slot full-size rackmount chassis, black, with ACE-935AL-RS, RoHS
RACK-814GB/ACE-832AP	4U 14-slot full-size rackmount chassis, black, with ACE-832AP-RS, RoHS

Backplane Options

Model No.	SBC Type	PCI	ISA	PCIe			PSU Connector
				x1	x4	x16	
BP-14S-RS-R30	ISA	0	14	0	0	0	AT
PCI-13SD-RS-R30	PICMG 1.0	3+4	3+3	0	0	0	AT/ATX
PCI-14S-RS-R30	PICMG 1.0	4	9	0	0	0	AT/ATX
PCI-14S2-RS-R30	PICMG 1.0	4	8	0	0	0	AT/ATX
PCI-14S3-RS-R30	PICMG 1.0	4	9	0	0	0	AT/ATX
PX-14S3-RS-R30	PICMG 1.0	12	2	0	0	0	AT/ATX
PX-14S5-RS-R30	PICMG 1.0	7	6	0	0	0	AT
PXAGP-13S3-RS-R30	PIAGP	11	0	0	0	0	AT/ATX
PE-6S	PICMG1.3	2	0	1	1	1	ATX
PE-10S	PICMG 1.3	4	0	3	1	1	ATX
PE-10S2	PICMG 1.3	4	0	4	0	1	ATX
PE-13SD	PICMG 1.3	4	0	5	0	2	ATX
PXE-13S	PICMG 1.3	8	0	3	0	1	ATX
PXE-13S2	PICMG 1.3	4	0	7	0	1	ATX
PXE-13S3	PICMG 1.3	3	0	0	8	1	ATX

Power Supply Options

Type	Model No.	Watt
AT	ACE-925AP-U-RS	250W
	ACE-935AL-RS	300W
	ACE-940AP-RS	390W
ATX	ACE-832AP-RS	300W
	ACE-841AP-S-RS	400W
	ACE-850AP-RS	500W
	ACE-4860AP-RS	600W
ATX Redundant	ACE-R4130AP-RS	300W

RACK-814G can support single PS/2 PSU. For more models of IEI PSU, please visit www.ieiworld.com

RACK-3000G

4U 14-slot Full-size Rackmount Chassis

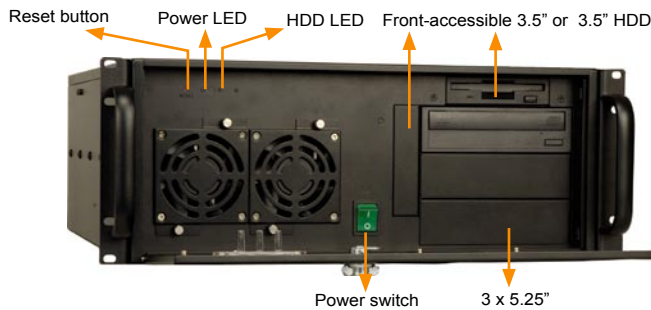

RACK-3000GATX

CD-ROM, FDD and HDD are not included in package



Features

- ◆ RoHS compliant design
- ◆ ATX model compatible with ATX and Micro ATX form factor motherboard
- ◆ 3 x 5.25" and 3 x 3.5" drive capacity
- ◆ 2 x 8cm cooling fans

Dimensions

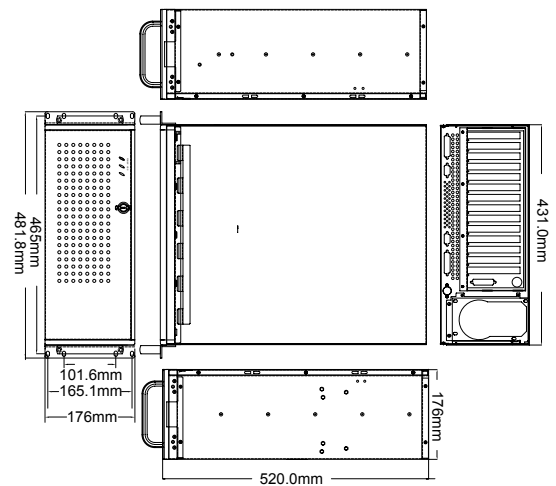

Specifications

◆ Construction	Heavy duty metal
◆ SBC Form Factor	Full-size, slot CPU card
◆ Drive Bays	3 x 5.25" + 1 x front-accessible 3.5" + 2 x 3.5" HDD or 3 x 5.25" + 2 x front-accessible 3.5" + 1 x 3.5" HDD or 3 x 5.25" + 3 x 3.5" HDD
◆ Cooling Fans	2 x 8cm
◆ I/O openings	2 x COM, 2 x LPT, 1 x PS2
◆ Expansion Slots	14 slots for RACK-3000G 7 slots for RACK-3000GATX
◆ Indicators	Power, HDD
◆ Buttons	Power switch, reset
◆ Operating Shock	10G acceleration peak to peak (11ms)
◆ Operating Vibration	5~17Hz, 0.1" double amplitude displacement 17~640Hz, 1.5G acceleration peak to peak
◆ Operating Temperature	0~40°C
◆ Operation Humidity	10% ~ 90%
◆ Color	W:White / B:Black
◆ Weight (Net/Gross)	13kg / 18kg
◆ Dimensions (DxWxH)	520mm x 431mm x 176mm

Backplane Options

Model No.	SBC Type	PCI	ISA	PCIe			PSU Connector
				x1	x4	x16	
BP-14S-RS-R30	ISA	0	14	0	0	0	AT
PCI-13SD-RS-R30	PICMG 1.0	3+4	3+3	0	0	0	AT/ATX
PCI-14S2-RS-R30	PICMG 1.0	4	8	0	0	0	AT/ATX
PCI-14S3-RS-R30	PICMG 1.0	4	9	0	0	0	AT/ATX
PX-14S3-RS-R30	PICMG 1.0	12	2	0	0	0	AT/ATX
PX-14S5-RS-R30	PICMG 1.0	7	6	0	0	0	AT/ATX
PXAGP-13S3-RS-R30	PCIAGP	11	0	0	0	0	AT/ATX
PE-6S	PICMG 1.3	2	0	1	1	1	ATX
PE-10S	PICMG 1.3	4	0	3	1	1	ATX
PE-10S2	PICMG 1.3	4	0	4	0	1	ATX
PE-13SD	PICMG 1.3	4	0	5	0	2	ATX
PXE-13S	PICMG 1.3	8	0	3	0	1	ATX
PXE-13S2	PICMG 1.3	4	0	7	0	1	ATX
PXE-13S3	PICMG 1.3	3	0	0	8	1	ATX

Power Supply Options

Type	Model No.	Watt
AT	ACE-935AL-RS	300W
	ACE-940AP-RS	390W
ATX	ACE-832AP-RS	300W
	ACE-841AP-RS	400W
	ACE-850AP-RS	500W
	ACE-4860AP-RS	600W
ATX Redundant	ACE-R4130AP-RS	300W

RACK-3000G can support single PS/2 PSU. For more models of IEI PSU, please visit www.ieiworld.com

Ordering Information

Part No.	Description
RACK-3000G [C] / ACE-832AP	4U 14-slot Rackmount chassis, with ACE-832AP-RS, RoHS
RACK-3000G [C] ATX / ACE-832AP	4U MB rackmount chassis, with ACE-832AP-RS, RoHS

[C] Color Code: B-Black W-White

RACK-3200G

4U 20-slot Full-size Rackmount Chassis

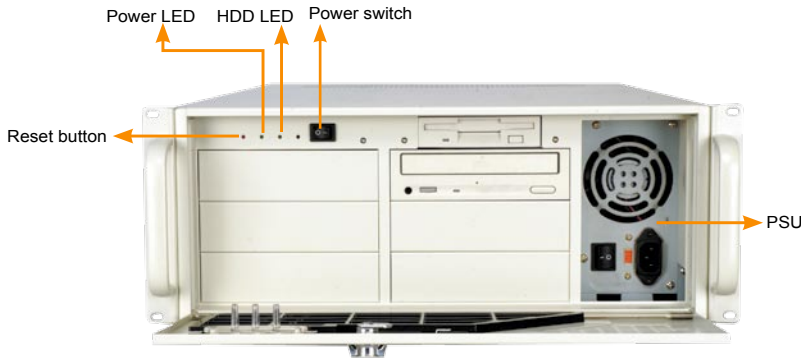

CD-ROM, FDD and HDD are not included in package



RACK-3200GW



RACK-3200GB

Features

- ◆ RoHS compliant design
- ◆ 4 x 8cm cooling fan with easy replaceable fan filter
- ◆ 20 slots high capacity model
- ◆ 6 x 5.25", 1 x 3.5" drive bays

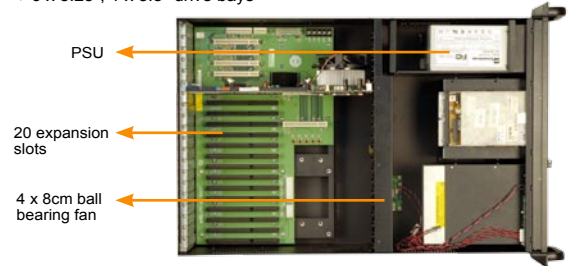

Dimensions

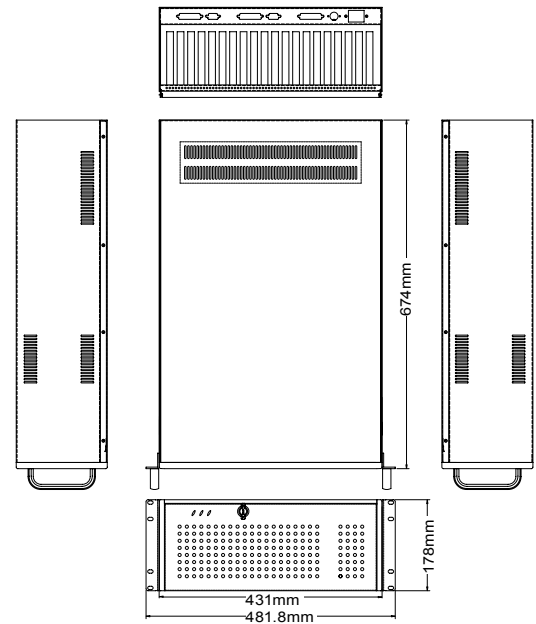

Specifications

◆ Construction	Heavy duty metal
◆ SBC Form Factor	Full-size, slot CPU card
◆ Drive Bays	1 x front-accessible 3.5" 6 x 5.25"
◆ Cooling Fans	4 x 8 cm
◆ I/O Openings	2 x COM, 3 x LPT, 1 x PS/2
◆ Expansion Slots	20 slots
◆ Indicators	Power, HDD
◆ Buttons	Power switch, reset
◆ Operating Temperature	0~50°C
◆ Operation Humidity	10% ~ 90%
◆ Color	W: White / B: Black
◆ Weight (Net/Gross)	15.4kg / 20.4kg
◆ Dimensions (DxWxH)	674mm x 431mm x 176mm

Backplane Options

Model No.	SBC Type	PCI	ISA	PCIe			PSU Connector
				x1	x4	x16	
PCI-19S-RS-R30	PICMG1.0	4	14	0	0	0	AT/ATX
PX-20S2-RS-R30	PICMG1.0	17	2	0	0	0	AT/ATX
PX-20S3-RS-R30	PICMG1.0	18	0	0	0	0	AT/ATX
PXE-19S	PICMG1.3	16	0	1	0	1	ATX

Power Supply Options

Type	Model No.	Watt
AT	ACE-925AP-U-RS	250W
	ACE-935AL-RS	300W
	ACE-940AP-RS	390W
ATX	ACE-832AP-RS	300W
	ACE-841AP-S-RS	400W
	ACE-850AP-RS	500W
	ACE-4860AP-RS	600W
ATX redundant	ACE-R4130AP-RS	300W

RACK-3200G can support single PS/2 PSU. For more models of IEI PSU, please visit www.ieiworld.com

Ordering Information

Part No.	Description
RACK-3200G □ / ACE-841AP-S	4U 20-slot rackmount chassis, with ACE-841AP-S-RS, RoHS

□ Color Code: B-Black W-White

RACK-500G

5U 5-slot Full-size Rackmount Chassis



Features

- ◆ RoHS compliant design
- ◆ 2 x USB ports on front panel
- ◆ 1 x front-accessible 3.5" and 1 x 3.5" HDD drive capacity
- ◆ Hot-replaceable 8 cm cooling fan
- ◆ 19" rack-mountable carrier (optional)



CA-950G

CA-950G – 19" rack carrier can carry 4 RACK-500G and fit into standard 19" width rack with 5U height.

Dimensions

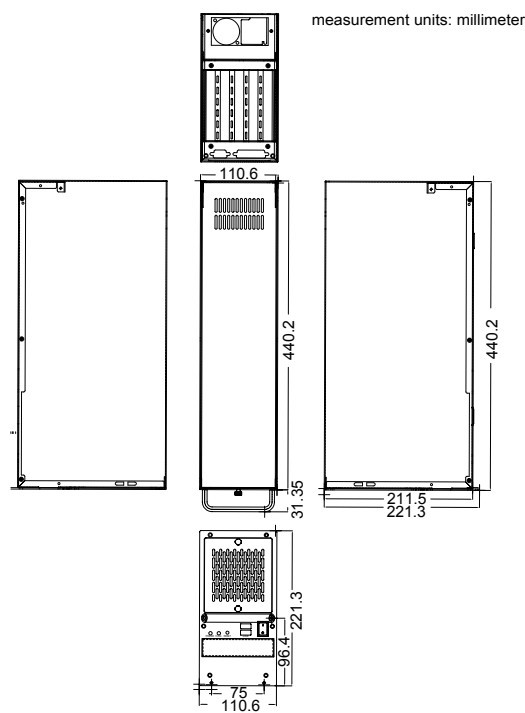

FDD and HDD are not included in package

LPT opening Com opening



Specifications

◆ Construction	Heavy duty metal
◆ SBC Form Factor	Full-size, slot CPU cards
◆ Drive Bays	1 x front-accessible 3.5" 1 x 3.5" HDD
◆ Cooling Fans	1 x 8cm
◆ I/O ports	2 x USB
◆ I/O openings	1 x LPT, 1 x COM
◆ Expansion Slots	5 slots
◆ Indicators	Power, HDD
◆ Buttons	Power switch, reset
◆ Operating Temperature	0~50°C
◆ Operation Humidity	10% ~ 90%
◆ Color	W: White / B: Black
◆ Weight (Net/Gross)	6kg / 9kg
◆ Dimensions (DxWxH)	440.2mm x 110.6mm x 221.3mm

Backplane Options

Model No.	SBC Type	PCI	ISA	PCIe			PSU Connector
				x1	x4	x16	
PCI-5S2-RS-R30	PICMG 1.0	4	1	0	0	0	AT
PE-5S2	PICMG 1.3	0	0	3	0	1	ATX

Power Supply Options

Type	Model No.	Watt
AT	ACE-916AP-RS	150W
	ACE-816AP-RS	150W
ATX	ACE-4525AP-RS	250W

RACK-500G can support single 1U height AT type PSU. For more models of IEI PSU, please visit www.ieiworld.com

Ordering Information

Part No.	Description
RACK-500G□ / ACE-916AP / PCI-5S2	5U 5-slot rackmount chassis, with ACE-916AP-RS and PCI-5S2-RS-R30, RoHS
CA-950GB	19" rack carrier for RACK-500G and RACK-900G, black, RoHS

□ Color Code: B-Black W-White

RACK-900G

5U 10-slot Full-size Rackmount Chassis

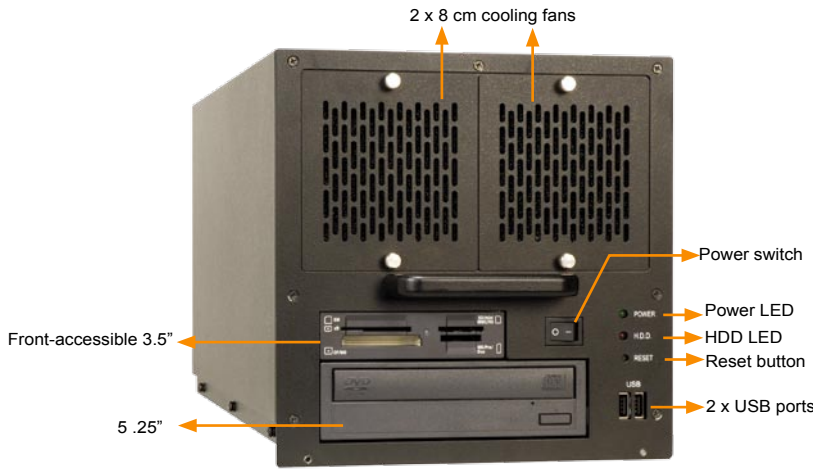

CD-ROM, FDD and HDD are not included in package.

Features

- ◆ RoHS compliant design
- ◆ 2 x USB ports on front panel
- ◆ 1 x 5.25", 1 x front-accessible 3.5" and 1 x 3.5" HDD drive capacity
- ◆ 2 x hot-replaceable 8 cm cooling fan
- ◆ 19" rack-mountable carrier (optional)



CA-950GB

CA-950G – 19" rack carrier can carry 2 RACK-900G and fit into standard 19" width rack with 5U height.

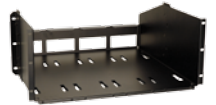

Dimensions

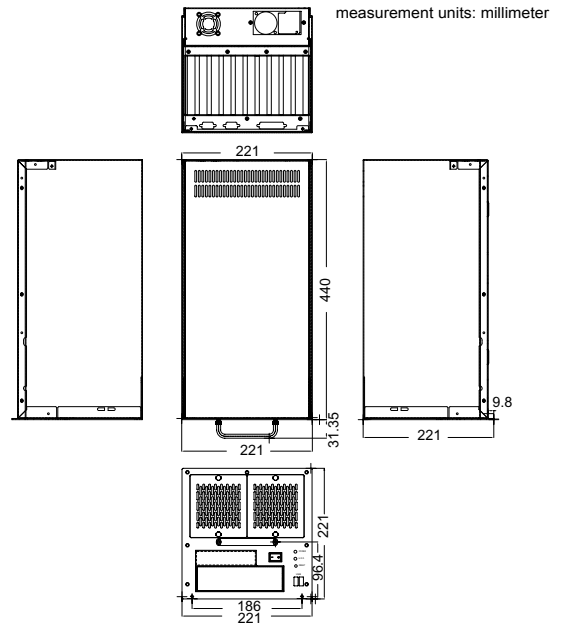

Specifications

◆ Construction	Heavy duty metal
◆ SBC Form Factor	Full-size, slot CPU cards
◆ Drive Bays	1 x 5.25" 1 x front-accessible 3.5" 1 x 3.5" HDD
◆ Cooling Fans	2 x 8cm + 1 x 4cm(optional)
◆ I/O ports	2 x USB
◆ I/O openings	1 x LPT, 2 x COM
◆ Expansion Slots	10 slots
◆ Indicators	Power, HDD
◆ Buttons	Power switch, reset
◆ Operating Temperature	0~50°C
◆ Operation Humidity	10% ~ 90%
◆ Color	B: Black
◆ Weight (Net/Gross)	10kg / 13kg
◆ Dimensions (DxWxH)	440mm x 221mm x 221mm

Ordering Information

Part No.	Description
RACK-900GB/ACE-4525AP/PCI-10S	5U 10-slot rackmount chassis, black, with ACE-916AP-RS and PCI-5S2-RS-R30, RoHS
CA-950GB	19" rack carrier for RACK-500G and RACK-900G, black, RoHS

Backplane Options

Model No.	SBC Interface	PCI	ISA	PSU Connector
PCI-10S2-RS-R30	PICMG 1.0	4	5	AT/ATX

Power Supply Options

Type	Model No.	Watt
ATX	ACE-816AP-RS	150W
	ACE-4518AP-RS	180W
	ACE-4525AP-RS	250W

RACK-900G can support single 1U height PSU. For more models of IEI PSU, please visit www.ieiworld.com

RACK-3035G

7U 20-slot Full-size Rackmount Chassis



CD-ROM, FDD and HDD are not included in package.

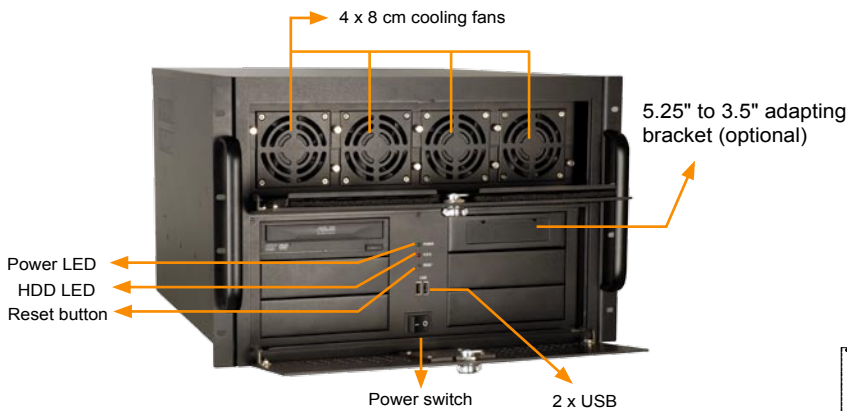

Features

- ◆ RoHS compliant design
- ◆ 2 x front-accessible USB ports
- ◆ 6 x 5.25" drive capacity
- ◆ 5 x 8 cm cooling fans



8cm cooling fan at the rear

63000-RHH6400P-RS
400W ATX redundant PSU

Dimensions

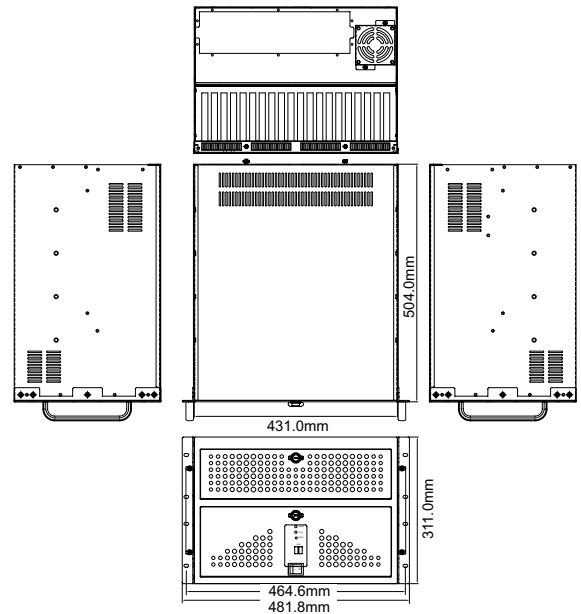

Specifications

◆ Construction	Heavy duty metal
◆ SBC Form Factor	Full-size, slot CPU cards
◆ Drive Bays	6 x 5.25"
◆ Cooling Fans	5 x 8cm
◆ I/O Ports	2 x USB
◆ Expansion Slots	20 slots
◆ Indicators	Power, HDD
◆ Buttons	Power switch, reset
◆ Operating Temperature	0~50°C
◆ Operation Humidity	10% ~ 90%
◆ Color	B: Black
◆ Weight (Net/Gross)	10.4kg / 15kg
◆ Dimensions (DxWxH)	504mm x 431mm x 311mm

Backplane Options

Model No.	SBC Type	PCI	ISA	PCIe			PSU Connector
				x1	x4	x16	
PCI-19S-RS-R30	PICMG 1.0	4	14	0	0	0	AT/ATX
PX-20S2-RS-R30	PICMG 1.0	17	2	0	0	0	AT/ATX
PX-20S3-RS-R30	PICMG 1.0	18	0	0	0	0	AT/ATX
PXE-19S	PICMG 1.3	16	0	1	0	1	ATX

Power Supply Options

Type	Model No.	Watt
ATX	63000-RHH6400P-RS	400W

Ordering Information

Part No.	Description
RACK-3035GB/RHH6400P	7U 20-slot Rackmount chassis, black, with 63000-RHH6400P-RS, RoHS

PAC-42GF

4-slot Full-size Compact Chassis



Features

- ◆ RoHS compliant design
- ◆ 2 x USB ports on front panel
- ◆ 1 x front-accessible 3.5" with 2 x 2.5" HDD or 2 x 3.5" HDD drive capacity
- ◆ Hot-replaceable 8 cm cooling fan

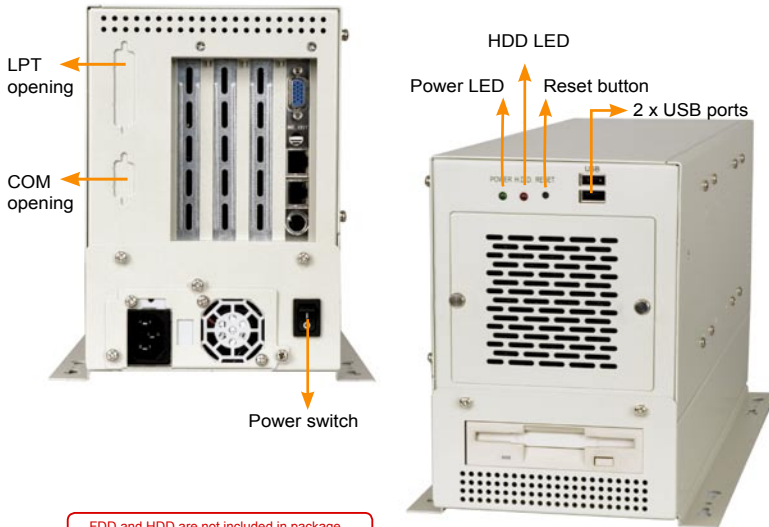

FDD and HDD are not included in package.

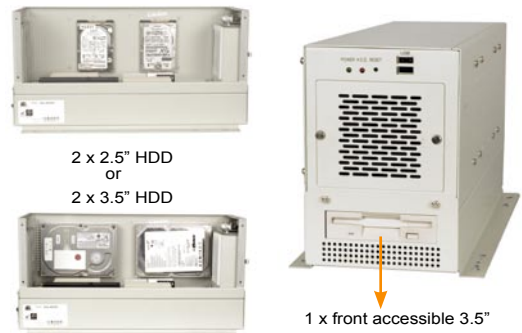

Dimensions

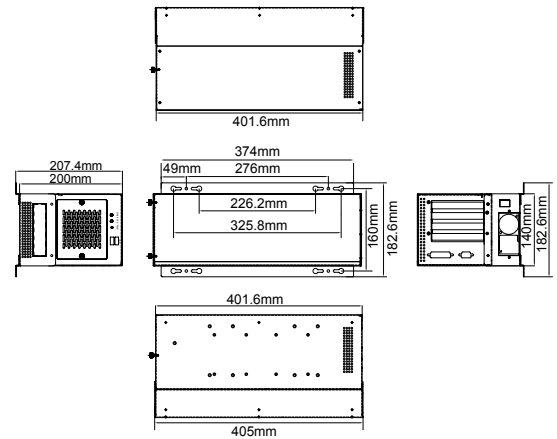

Specifications

◆ Construction	Heavy duty metal
◆ SBC Form Factor	Full-size, slot CPU cards
◆ Drive Bays	1 x front-accessible 3.5" with 2 x 3.5" HDD or 1 x front-accessible 3.5" with 2 x 2.5" HDD
◆ Cooling Fans	1 x 8 cm
◆ I/O ports	2 x USB
◆ I/O openings	1 x LPT , 1 x COM
◆ Expansion Slots	4 slots
◆ Indicators	Power, HDD
◆ Buttons	Power switch, reset
◆ Operating Temperature	0~50°C
◆ Operation Humidity	10% ~ 90%
◆ Color	W: White
◆ Weight (Net/Gross)	4.6kg / 6.8kg
◆ Dimensions (DxWxH)	405mm x 140mm x 200mm

Ordering Information

Part No.	Description
PAC-42GFW/ACE-4518AP/PCI-4S	4-slot full-size chassis, white, with ACE-4518AP-RS and PCI-4S-RS-R30, RoHS

Backplane Options

Model No.	SBC Type	PCI	ISA	PCIe			PSU Connector
				x1	x4	x16	
PCI-4S-RS-R30	PICMG 1.0	3	1	0	0	0	AT/ATX
PE-4S	PCIMG 1.3	1	0	1	1	1	ATX
PE-4S2	PCIMG 1.3	2	0	0	0	1	ATX
PE-4S3	PCIMG 1.3	0	0	2	0	1	ATX
HPE-4S1	PCI/PICoE	3	0	0	0	0	ATX
HPE-4S2	PCI/PICoE	2	0	0	1	0	ATX

Power Supply Options

Type	Model No.	Watt
AT	ACE-916AP-RS	150W
	ACE-816AP-RS	150W
ATX	ACE-4518AP-RS	180W

PAC-42GF can support single 1U height PSU. For more models of IEI PSU, please visit www.ieiworld.com.

PAC-1000G

6-slot Full-size Compact Chassis

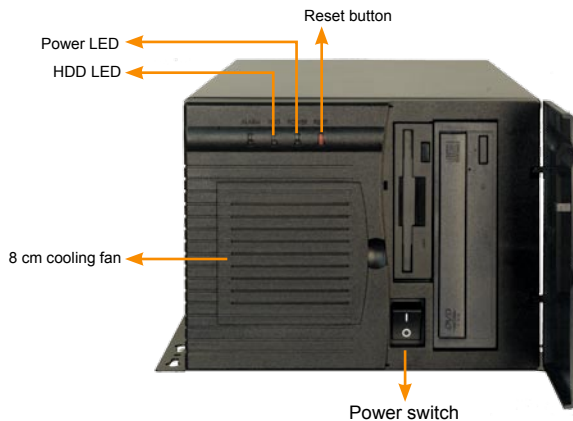

CD-ROM, FDD and HDD are not included in package



Features

- ◆ RoHS compliant design
- ◆ 1 x 8 cm cooling fan with easy replaceable fan filter
- ◆ Plastic front panel with cover door

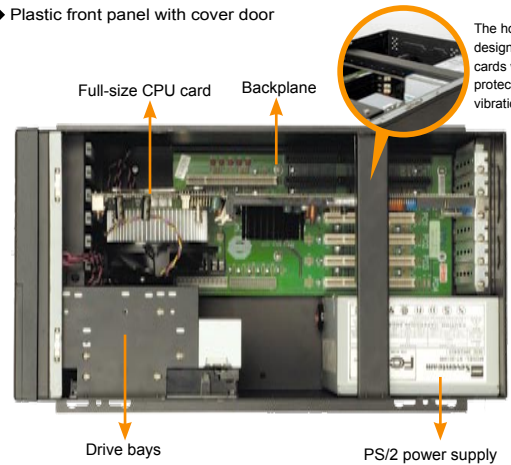

The hold-down clamp is designed to secure the cards within the chassis, protecting them from vibration.

Dimensions

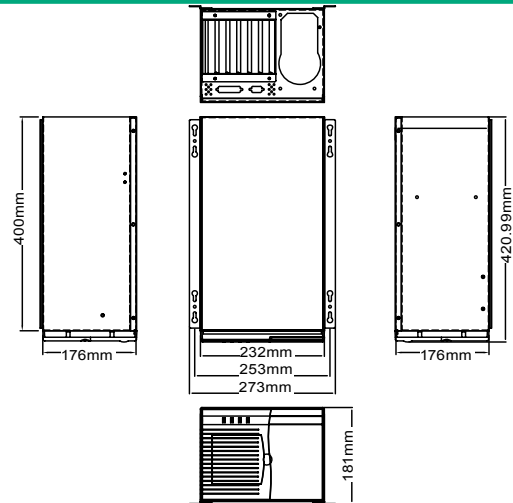

Backplane Options

Model No.	SBC Type	PCI	ISA	PCIe			PSU Connector
				x1	x4	x16	
BP-6S-RS-R30	ISA	0	6	0	0	0	AT
IP-6S-RS-R30	PCISA	3	2	0	0	0	AT
IP-6SA-RS-R30	PCISA	3	2	0	0	0	ATX
PCI-6S-RS-R30	PICMG 1.0	4	2	0	0	0	AT/ATX
PCIAGP-5S-RS-R30	PIAGP	3	0	0	0	0	AT/ATX
PE-6S2	PICMG 1.3	3	0	1	0	1	ATX
PE-6S3	PICMG 1.3	1	0	3	0	1	ATX

Power Supply Options

Type	Model No.	Watt
AT	ACE-925AP-U-RS	250W
	ACE-940AP-RS	390W
ATX	ACE-832AP-RS	300W
	ACE-841AP-S-RS	400W

PAC-1000G can support single PS/2 PSU. For more models of IEI PSU, please visit www.ieiworld.com

Specifications

◆ Construction	Metal with plastic front panel
◆ SBC Form Factor	Full-size, slot CPU card
◆ Drive Bays	1 x front- accessible 3.5" 1 x 5.25" 1 x 3.5" HDD
◆ Cooling Fans	1 x 8cm
◆ I/O openings	1 x LPT, 1 x COM
◆ Expansion Slots	6 slots
◆ Indicators	Power, HDD
◆ Buttons	power switch, reset
◆ Operating Temperature	0~50°C
◆ Operation Humidity	10% ~ 90%
◆ Color	B: Black
◆ Weight (Net/ Gross)	5.6kg / 8.8kg
◆ Dimension (DxWxH)	421mm x 232mm x 176mm

Ordering Information

Part No.	Description
PAC-1000GB/ ACE-832AP	6-slot full-size chassis, black, with ACE-832AP-RS, RoHS

PAC-106G

6-slot Full-size Compact Chassis

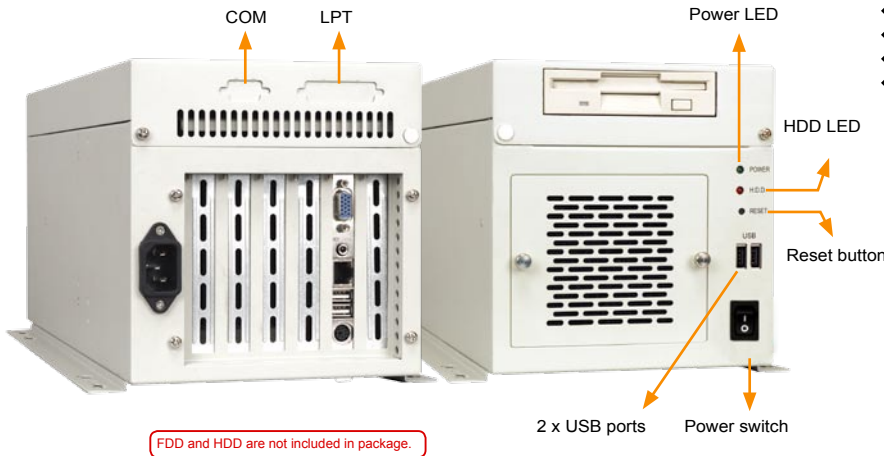

FDD and HDD are not included in package.

Features

- ◆ RoHS compliant design
- ◆ 2 x front-accessible USB ports
- ◆ 1 x 3.5" front accessible + 1 x 3.5" HDD drive capacity
- ◆ 1 x 8 cm cooling fans

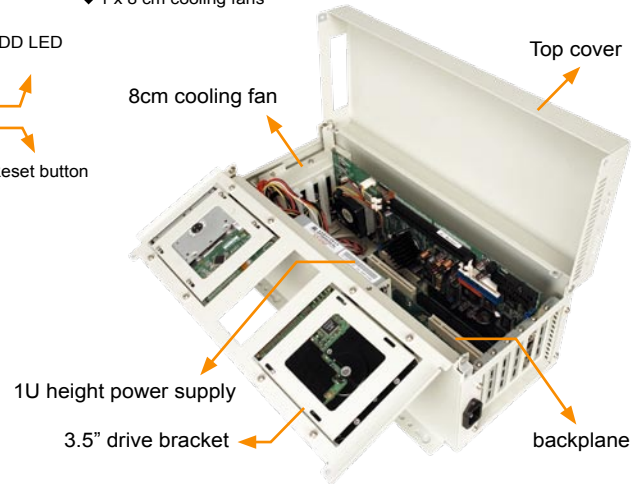

Specifications

◆ Construction	Heavy duty metal
◆ SBC Form Factor	Full-size, slot CPU card
◆ Drive Bays	1 x front-accessible 3.5" 1 x 3.5" HDD
◆ Cooling Fans	1 x 8 cm
◆ I/O Ports	2 x USB
◆ I/O openings	1 x COM, 1 x LPT
◆ Expansion Slots	6 slots
◆ Indicators	Power, HDD
◆ Buttons	Power switch, reset
◆ Operating Temperature	0~50°C
◆ Operation Humidity	10% ~ 90%
◆ Color	W: White
◆ Weight (Net/Gross)	5.2kg / 7.8kg
◆ Dimensions (DxWxH)	400mm x 166mm x 175.5mm

Dimensions

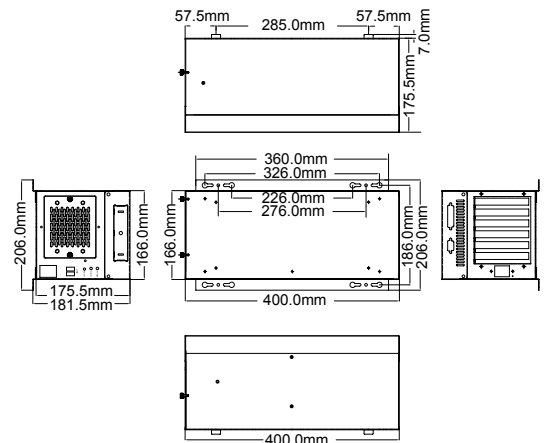

Backplane Options

Model No.	SBC Type	PCI	ISA	PCIe			PSU Connector
				x1	x4	x16	
BP-6S-RS-R30	ISA	0	6	0	0	0	AT
IP-6S-RS-R30	PCISA	3	2	0	0	0	AT
IP-6SA-RS-R30	PCISA	3	2	0	0	0	ATX
PCI-6S-RS-R30	PICMG 1.0	4	2	0	0	0	AT/ATX
PE-5S	PICMG 1.3	2	0	1	0	1	ATX
PE-6S2	PICMG 1.3	3	0	1	0	1	ATX
PE-6S3	PICMG 1.3	1	0	3	0	1	ATX

Power Supply Options

Type	Model No.	Watt
AT	ACE-916AP-RS	150W
	ACE-816AP-RS	150W
ATX	ACE-4518AP-RS	180W

PAC-106G can support single 1U height PSU, for more models of IEI PSU, please visit www.ieiworld.com

Ordering Information

Part No.	Description
PAC-106GW / ACE-4518AP	6-slot full-size chassis, white, with ACE-4518AP-RS, RoHS

PAC-107G

6-slot Full-size Compact Chassis

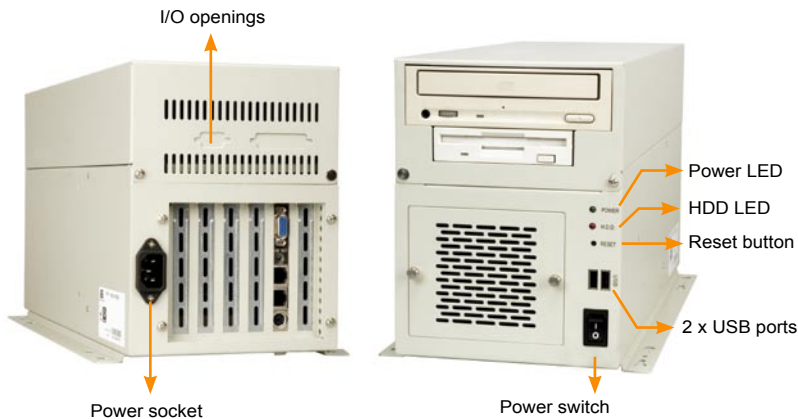

CD-ROM, FDD and HDD are not included in package.

Features

- ◆ RoHS compliant design
- ◆ 2 x USB ports on front panel
- ◆ 1 x 8cm cooling fan with easy replaceable fan filter
- ◆ Supports 1 x 5.25", 1 x front-accessible 3.5" and 1 x 3.5" HDD
- ◆ Hot-replaceable fan design

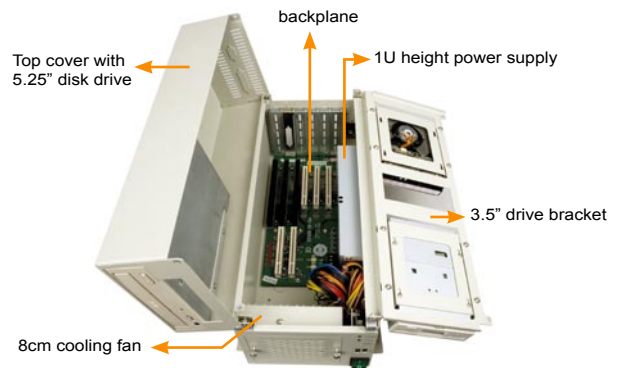

Specifications

◆ Construction	Heavy duty metal
◆ SBC Form Factor	Full-size, slot CPU card
◆ Drive Bays	1 x front-accessible 3.5"
	1 x 5.25"
◆ Cooling Fans	1 x 8 cm
	1 x 3.5" HDD
◆ I/O Openings	1 x LPT, 1 x COM
◆ Expansion Slots	6 slots
◆ Indicators	Power, HDD
◆ Buttons	Power switch, reset
◆ Operating Temperature	0~50°C
◆ Operation Humidity	10% ~ 90%
◆ Color	W: White
◆ Weight (Net / Gross)	5.4kg / 8kg
◆ Dimensions (DxWxH)	400mm x 166mm x 218.5mm

Dimensions

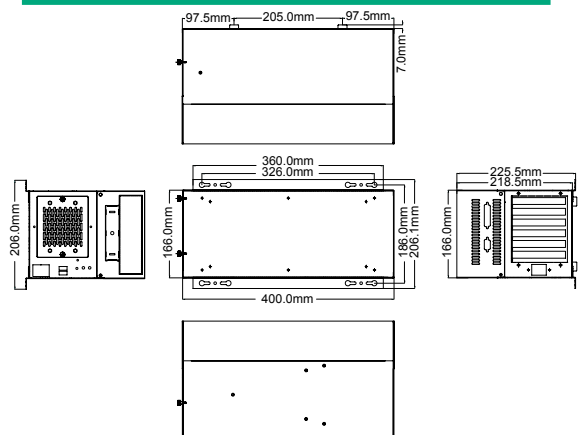

Backplane Options

Model No.	SBC Type	PCI	ISA	PCIe			PSU Connector
				x1	x4	x16	
IP-6S RS-R30	PCISA	3	2	0	0	0	AT
IP-6SA-RS-R30	PCISA	3	2	0	0	0	ATX
PCI-6S-RS-R30	PICMG 1.0	4	2	0	0	0	AT/ATX
PE-6S2	PICMG 1.3	3	0	1	0	1	ATX
PE-6S3	PICMG 1.3	1	0	3	0	1	ATX

Power Supply Options

Type	Model No.	Watt
AT	ACE-916AP-RS	150W
	ACE-816AP-RS	150W
ATX	ACE-4518AP-RS	180W

PAC-107G can support single 1U height PSU. For more models of IEI PSU, please visit www.ieiworld.com.

Ordering Information

Part No.	Description
PAC-107GW/ ACE-816AP	6-slot full-size chassis, white, with ACE-816AP-RS, RoHS
PAC-107GW/ ACE-916AP	6-slot full-size chassis, white, with ACE-916AP-RS, RoHS

PAC-1700G

7-slot Full-size Compact Chassis

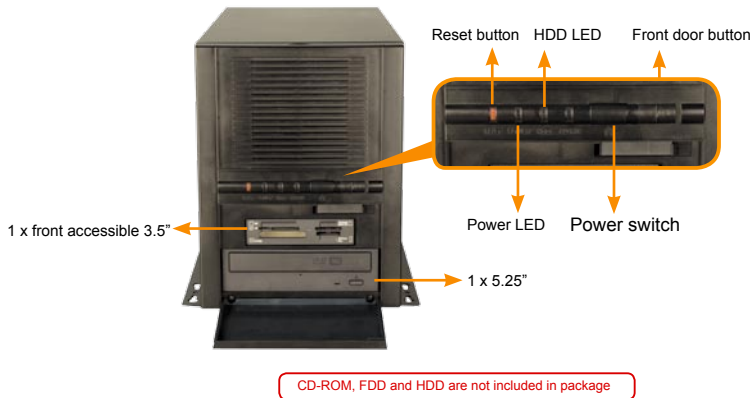

Features

- ◆ RoHS compliant design
- ◆ 1 x 5.25", 1 x front accessible 3.5", 2 x 3.5" HDD
- ◆ 1 x 8 cm cooling fan
- ◆ 7 expansion slots, compatible with full-size SBC



Replaceable fan filter

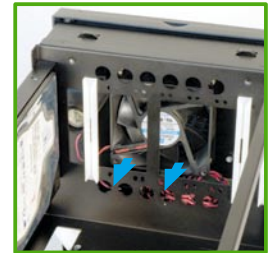

8 cm cooling fan



Dimensions

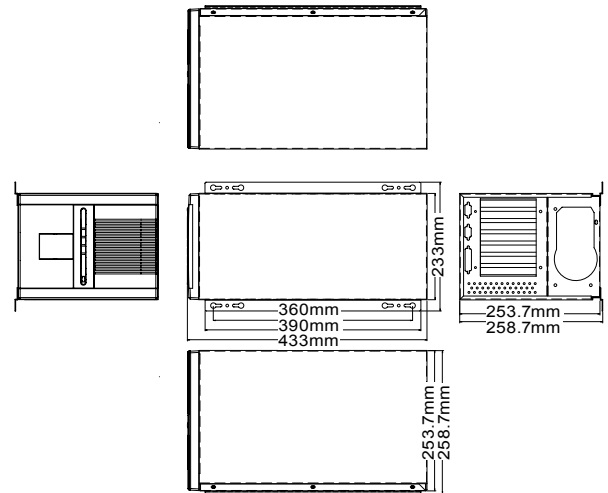

Specifications

◆ Construction	Metal with plastic front panel
◆ SBC Form Factor	Full-size, slot CPU card
◆ Drive Bays	1 x front-accessible 3.5" 1 x 5.25" 2 x 3.5" HDD
◆ Cooling Fans	1 x 8cm
◆ I/O openings	1 x LPT, 2 x COM
◆ Expansion Slots	7 slots
◆ Indicators	Power, HDD
◆ Buttons	power switch, reset
◆ Operating Temperature	0~50°C
◆ Operation Humidity	10% ~ 90%
◆ Color	B: Black
◆ Weight (Net/ Gross)	6kg / 8.4kg
◆ Dimension (DxWxH)	433mm x 233mm x 253.7mm

Backplane Options

Model No.	SBC Type	PCI	ISA	PCIe			PSU Connector
				x1	x4	x16	
IP-7SA-RS-R30	PCISA	4	2	0	0	0	AT
PCI-7S-RS-R30	PICMG 1.0	4	3	0	0	0	AT/ATX
PE-6S	PICMG 1.3	2	0	1	1	1	ATX
PE-7S	PICMG 1.3	3	0	2	0	1	ATX
PE-7S2	PICMG 1.3	1	0	4	0	1	ATX
HPE-7S1	PCI/PIC0e	4	0	2	0	1	ATX

Power Supply Options

Type	Model No.	Watt
AT	ACE-925AP-U-RS	250W
	ACE-940AP-RS	390W
ATX	ACE-832AP-RS	300W
	ACE-841AP-S-RS	400W

PAC-1700G can support single PS/2 PSU. For more models of IEI PSU, please visit www.ieiworld.com.

Ordering Information

Part No.	Description
PAC-1700GB/ ACE-832AP	7-slot full-size chassis, black, with ACE-832AP-RS, RoHS

PAC-125G

10-slot Full-size Compact Chassis

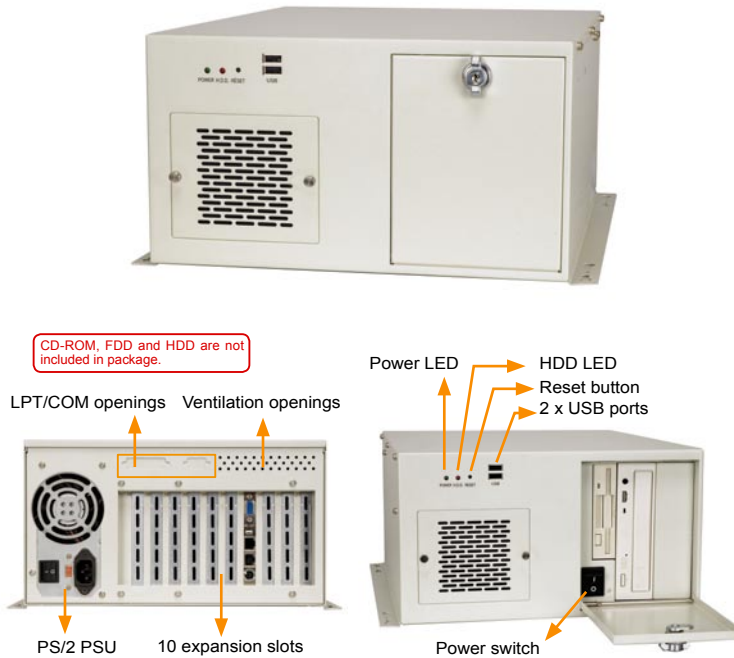

Features

- ◆ RoHS compliant design
- ◆ 2 x USB ports on front panel
- ◆ 1 x 8 cm hot-replaceable cooling fan with fan filter
- ◆ 2 x 5.25", 1 x 3.5" HDD, 1 x front-accessible 3.5"

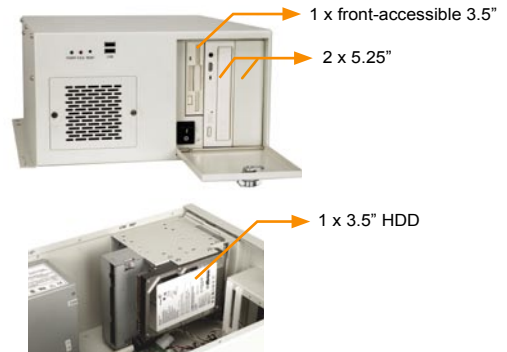

Dimensions

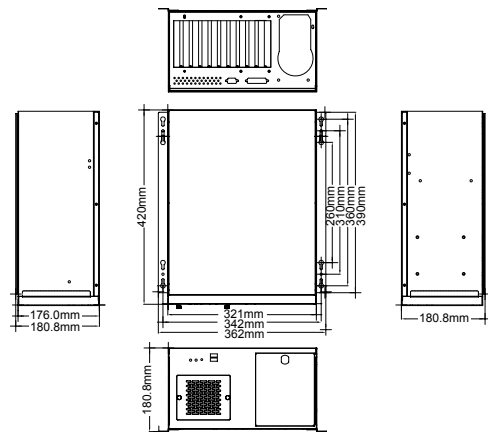

Specifications

◆ Construction	Heavy duty metal
◆ SBC Form Factor	Full-size, slot CPU card
◆ Drive Bays	2 x 5.25" 1 x front accessible 3.5" 1 x 3.5" HDD
◆ Cooling Fans	1 x 8cm
◆ I/O Ports	2 x USB
◆ I/O openings	1 x LPT, 1 x COM
◆ Expansion Slots	10 slots
◆ Indicators	Power, HDD
◆ Buttons	Power switch, reset
◆ Operating Temperature	0~50°C
◆ Operation Humidity	10% ~ 90%
◆ Color	W: White
◆ Weight (Net/ Gross)	7.2 kg / 10.4 kg
◆ Dimensions (DxWxH)	420mm x 321mm x 176mm

Backplane Options

Model No.	SBC Type	PCI	ISA	PCIe			PSU Connector
				x1	x4	x16	
BP-10S-RS-R30	ISA	0	10	0	0	0	AT
PCI-10S-RS-R30	PICMG 1.0	4	5	0	0	0	AT/ATX
PX-10S-RS-R30	PICMG 1.0	7	3	0	0	0	AT/ATX
IP-10S-RS-R30	PCISA	4	5	0	0	0	AT/ATX
IPX-9S-RS-R30	PCISA	8	0	0	0	0	AT/ATX
PE-6S	PICMG 1.3	2	0	1	1	1	ATX
PE-8S	PICMG 1.3	3	0	3	0	1	ATX
PE-9S	PICMG 1.3	3	0	4	0	1	ATX
HPE-8S0	PCI/PIC0e	4	0	2	0	0	ATX

Power Supply Options

Type	Model No.	Watt
AT	ACE-925AP-U-RS	250W
	ACE-935AL-RS	300W
ATX	ACE-832AP-RS	300W
	ACE-841AP-S-RS	400W
	ACE-850AP-RS	500W

PAC-125G can support single PS/2 PSU. For more models of IEI PSU, please visit www.ieiworld.com

Ordering Information

Part No.	Description
PAC-125GW/ACE-925AP-U	10-slot full-size chassis, white, with ACE-925AP-U-RS, RoHS

PAC-53GH

3-slot Half-size Compact Chassis

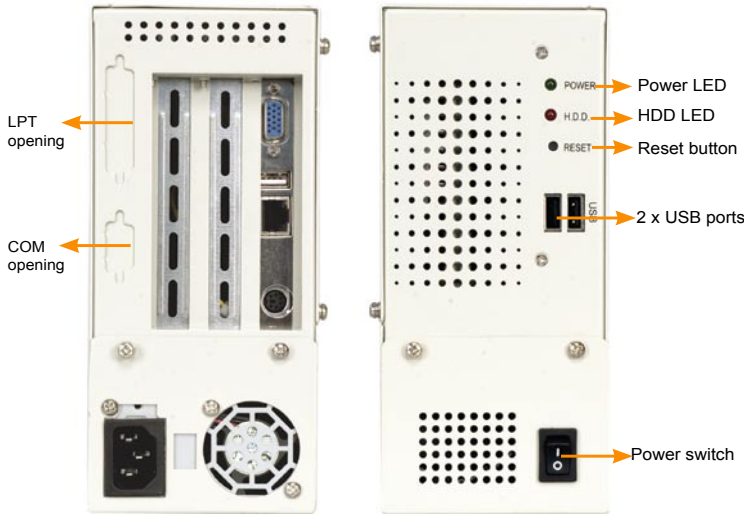

HDD is not included in package.

Features

- ◆ RoHS compliant design
- ◆ 2 x USB ports on front panel
- ◆ 1 x 2.5" HDD drive capacity
- ◆ HDD bracket with anti-vibration rubbers



Dimensions

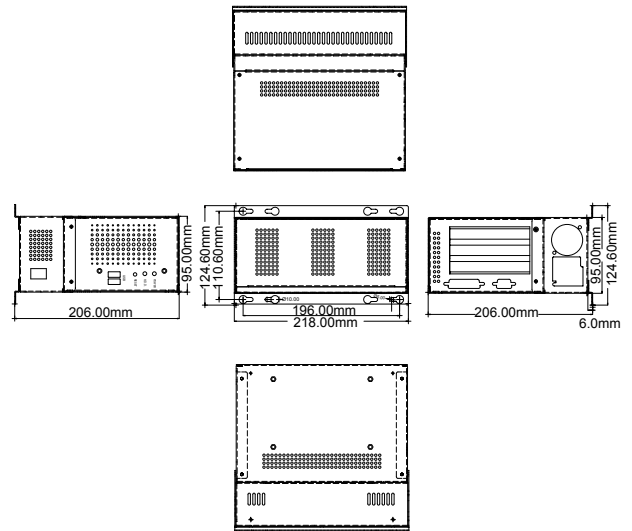

Specifications

◆ Construction	Heavy duty metal
◆ SBC Form Factor	Half-size, slot CPU cards
◆ Drive Bays	1 x 2.5" HDD
◆ I/O ports	2 x USB
◆ I/O openings	1 x LPT , 1 x COM
◆ Expansion Slots	3 slots
◆ Indicators	Power, HDD
◆ Buttons	Power switch, reset
◆ Operating Temperature	0~50°C
◆ Operation Humidity	10% ~ 90%
◆ Color	W: White
◆ Weight (Net/Gross)	2kg / 3.8kg
◆ Dimensions (DxWxH)	218mm x 95mm x 200mm

Backplane Options

Model No.	SBC Type	PCI	ISA	PCIe			PSU Connector
				x1	x4	x16	
BP-3S-RS-R30	ISA	0	2	0	0	0	AT
IP-3S-RS-R30	PCISA	2	0	0	0	0	ATX
IP-3SA-RS-R30	PCISA	2	1	0	0	0	ATX
HPE-3S1	PCI/PICoE	2	0	0	0	0	ATX
HPE-3S2	PCI/PICoE	1	0	0	1	0	ATX

Power Supply Options

Type	Model No.	Watt
AT	ACE-916AP-RS	150W
ATX	ACE-816AP-RS	150W
	ACE-4518AP-RS	180W

PAC-53GH can support single 1U height PSU. For more models of IEI PSU, please visit www.ieiworld.com

Ordering Information

Part No.	Description
PAC-53GHW/ACE-916AP/IP-3S	3-slot half-size chassis, with ACE-916AP-RS and IP-3S-RS-R30, RoHS
PAC-53GHW/ACE-916AP/BP-3S	3-slot half-size chassis, with ACE-916AP-RS and BP-3S-RS-R30, RoHS
PAC-53GHW/ACE-816AP/IP-3SA	3-slot half-size chassis, with ACE-816AP-RS and IP-3SA-RS-R30, RoHS

PR-1300G

3-slot Half-size Compact Chassis

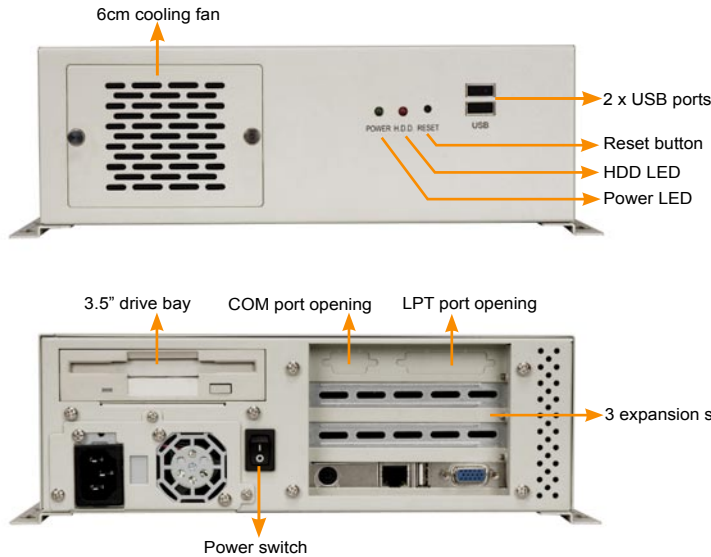

FDD and HDD are not included in package.

Features

- ◆ RoHS compliant design
- ◆ 1 x 3.5" drive capacity
- ◆ 2 x front-accessible USB ports
- ◆ 1 x 6cm cooling fan



Dimensions

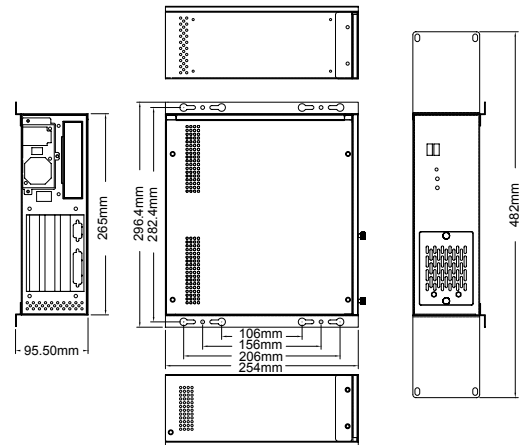

Specifications

◆ Construction	Heavy duty metal
◆ SBC Form Factor	Half-size, slot SBC
◆ Drive Bays	1 x 3.5" (front accessible / HDD)
◆ Cooling Fans	1 x 6 cm
◆ I/O ports	2 x USB
◆ I/O openings	1 x LPT , 1 x COM
◆ Expansion Slots	3 slots
◆ Indicators	Power, HDD
◆ Buttons	Power switch, reset
◆ Operating Temperature	0~50°C
◆ Operation Humidity	10% ~ 90%
◆ Color	W: White
◆ Weight (Net/Gross)	2.6kg / 5.2kg
◆ Dimensions (DxWxH)	254mm x 265mm x 95.5mm

Backplane Options

Model No.	SBC Type	PCI	ISA	PCIe			PSU Connector
				x1	x4	x16	
BP-3S-RS-R30	ISA	0	2	0	0	0	AT
IP-3S-RS-R30	PCISA	2	0	0	0	0	AT
IP-3SA-RS-R30	PCISA	2	0	0	0	0	ATX
HPE-3S1	PCI/PICoE	2	0	0	0	0	ATX
HPE-3S2	PCI/PICoE	1	0	0	1	0	ATX

Power Supply Options

Type	Model No.	Watt
ATX	ACE-916AP-RS	150W
	ACE-816AP-RS	150W
	ACE-4518AP-RS	180W

PR-1300G can support single 1U height PSU. For more models of IEI PSU, please visit www.ieiworld.com

Ordering Information

Part No.	Description
PR-1300GW/ACE-916AP/BP-3S	3-slot half-size chassis, white, with ACE-916AP-RS and BP-3S-RS-R30, RoHS
PR-1300GW/ACE-916AP/IP-3S	3-slot half-size chassis, white, with ACE-916AP-RS and IP-3S-RS-R30, RoHS
PR-1300GW/ACE-816AP/IP-3SA	3-slot half-size chassis, white, with ACE-816AP-RS and IP-3SA-R30, RoHS

PAC-42GH

4-slot Half-size Compact Chassis

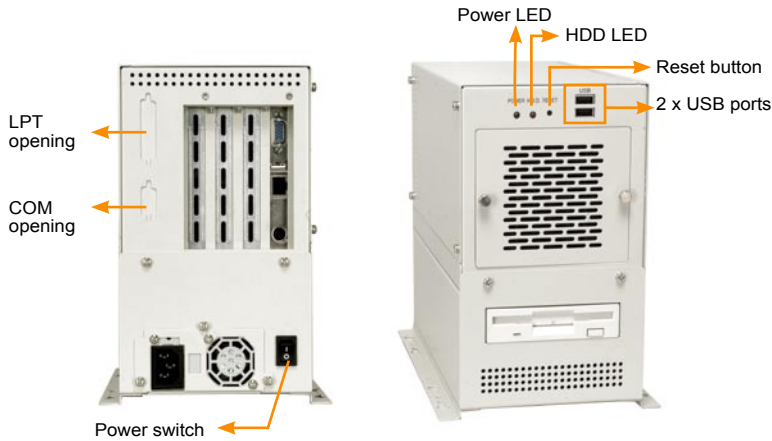

FDD and HDD are not included in package.

Features

- ◆ 2 x USB ports on front panel
- ◆ 1 x 8cm cooling fan with replaceable fan filter
- ◆ Supports 1x front accessible 3.5" with 1x 3.5" HDD or 2 x 2.5" HDD

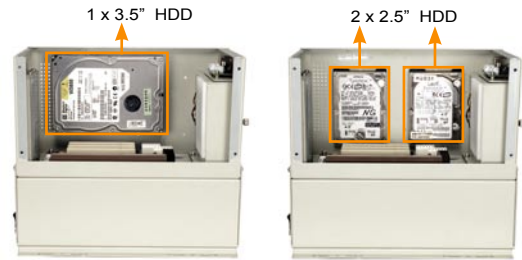

Dimensions

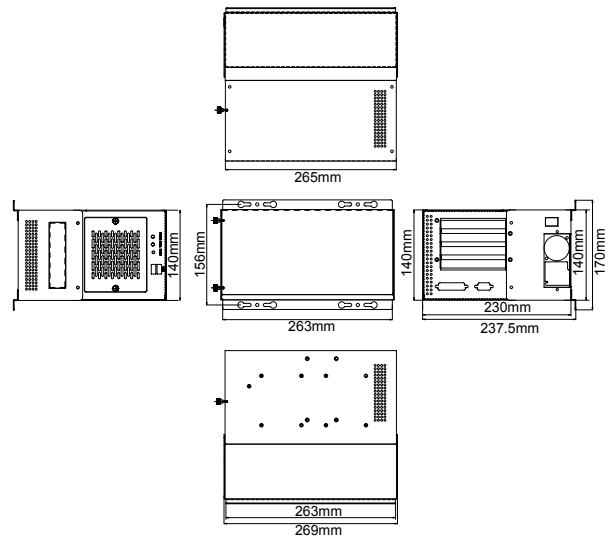

Specifications

◆ Construction	Heavy duty metal
◆ SBC Form Factor	Half-size, slot CPU cards
◆ Drive Combinations	1 x front-accessible 3.5" with 1 x 3.5" HDD or 1 x front-accessible 3.5" with 2 x 2.5" HDD
◆ Cooling Fans	1 x 8 cm
◆ I/O ports	2 x USB
◆ I/O Openings	1 x LPT, 1 x COM
◆ Expansion Slots	4 slots
◆ Indicators	Power, HDD
◆ Buttons	Power switch, reset
◆ Operating Temperature	0~50°C
◆ Operation Humidity	10% ~ 90%
◆ Color	W: White
◆ Weight (Net / Gross)	3.9kg / 6.1kg
◆ Dimensions (DxWxH)	269mm x 140mm x 230mm

Backplane Options

Model No.	SBC Type	PCI	ISA	PCIe			PSU Connector
				x1	x4	x16	
BP-4S-RS-R30	ISA	0	4	0	0	0	AT
IP-4S-RS-R30	PCISA	3	0	0	0	0	AT
IP-4S2-RS-R30	PCISA	2	1	0	0	0	ATX
IP-4SA-RS-R30	PCISA	3	0	0	0	0	ATX
IP-4S2A-RS-R30	PCISA	3	0	0	0	0	ATX
HPE-4S1	PCI/PICoE	3	0	0	0	0	ATX
HPE-4S2	PCI/PICoE	2	0	0	1	0	ATX

Power Supply Options

Type	Model No.	Watt
AT	ACE-916AP-RS	150W
ATX	ACE-816AP-RS	150W
ATX	ACE-4518AP-RS	150W

PAC-42GH can support single 1U height PSU. For more models of IEI PSU, please visit www.ieiworld.com

Ordering Information

Part No.	Description
PAC-42GHW/ACE-916AP/IP-4S	4-slot half-size chassis with ACE-916AP-RS and IP-4S-RS-R30, RoHS
PAC-42GHW/ACE-916AP/BP-4S	4-slot Half-size chassis with ACE-916AP-RS and BP-4S-RS-R30, RoHS
PAC-42GHW/ACE-916AP/IP-4S2	4-slot half-size chassis with ACE-916AP-RS and IP-4S2-RS-R30, RoHS

PR-1500G

5-slot Half-size Compact Chassis

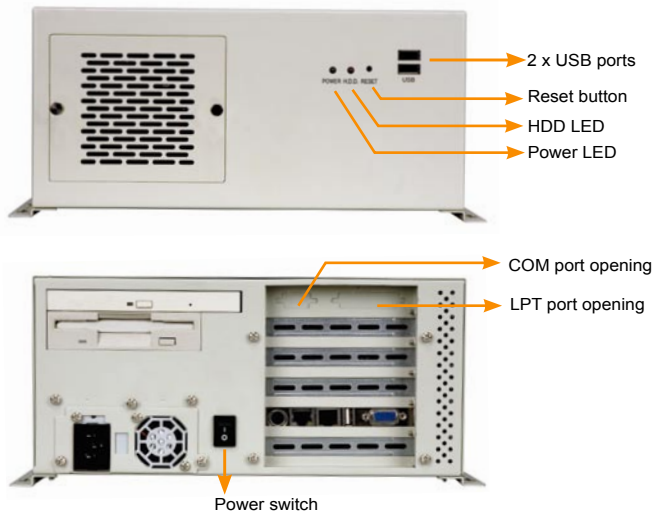

CD-ROM, FDD and HDD are not included in package.

Features

- ◆ RoHS compliant design
- ◆ 1 x front-accessible 3.5", 1 x 3.5" HDD and 1 x slim type CD-ROM drive capacity
- ◆ 2 x front-accessible USB ports
- ◆ 1 x 8cm cooling fan

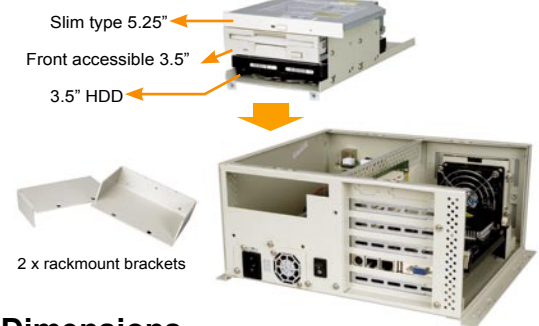

Dimensions

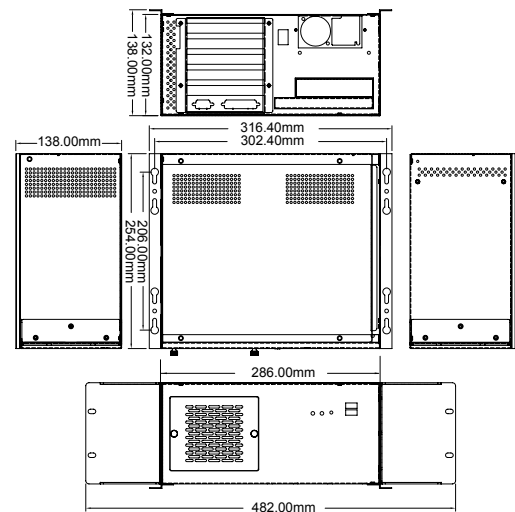

Backplane Options

Model No.	SBC Type	PCI	ISA	PCIe			PSU Connector
				x1	x4	x16	
BP-5S-RS-R30	ISA	0	5	0	0	0	AT
IP-5S2-RS-R30	PCISA	4	0	0	0	0	AT
IP-5SA-RS-R30	PCISA	3	1	0	0	0	ATX
IP-5SA2-RS-R30	PCISA	4	1	0	0	0	ATX
HPE-5S1	PCI/PICoE	4	0	0	0	0	ATX
HPE-5S2	PCI/PICoE	3	0	0	1	0	ATX
HPE-5S3	PCI/PICoE	2	0	2	0	0	ATX

Power Supply Options

Type	Model No.	Watt
AT	ACE-916AP-RS	150W
	ACE-816AP-RS	150W
ATX	ACE-4518AP-RS	180W
	ACE-4525AP-RS	250W

PR-1500G can support single 1U height PSU. For more models of IEI PSU, please visit www.ieiworld.com

Specifications

◆ Construction	Heavy duty metal
◆ SBC Form Factor	Half-size, slot SBC
◆ Drive Bays	1 x 3.5" HDD 1 x front accessible 3.5" 1 x slim 5.25"
◆ Cooling Fans	1 x 8 cm
◆ I/O ports	2 x USB
◆ I/O openings	1 x LPT , 1 x COM
◆ Expansion Slots	5 slots
◆ Indicators	Power, HDD
◆ Buttons	Power switch, reset
◆ Operating Temperature	0~50°C
◆ Operation Humidity	10% ~ 90%
◆ Color	W: White
◆ Weight (Net/Gross)	3.6kg / 6.2kg
◆ Dimensions (DxWxH)	254mm x 286mm x 132mm

Ordering Information

Part No.	Description
PR-1500GW/ACE-916AP	5-slot half-size chassis, white, with ACE-916AP-RS, RoHS
PR-1500GW/ACE-816AP	5-slot half-size chassis, white, with ACE-816AP-RS, RoHS
PR-1500GW/ACE-4525AP	5-slot half-size chassis, white, with ACE-4525AP-RS, RoHS

PAC-400G

5-slot Half-size Compact Chassis



Features

- ◆ RoHS compliant design
- ◆ 2 x front-accessible USB ports
- ◆ 1 x 8cm hot replaceable fan
- ◆ Supports 1 x 3.5" internal HDD or 1 x 3.5" removable drive(optional)
- ◆ Supports Pentium 4 half-size CPU card

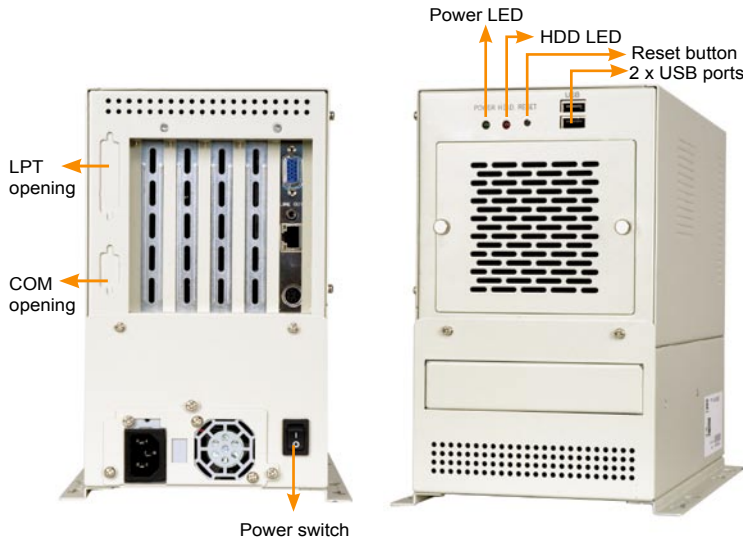

3.5" SATA/IDE removable drive bay compatible

HDD and removable drive bay are not included in package.

Dimensions

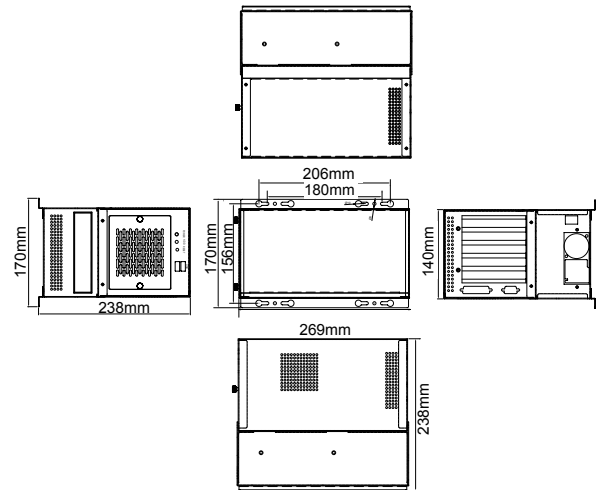

Specifications

◆ Construction	Heavy duty metal
◆ SBC Form Factor	Half-size, slot SBC
◆ Drive Bays	1 x 3.5" HDD
◆ Cooling Fans	1 x 8 cm
◆ I/O ports	2 x USB
◆ I/O openings	1 x LPT , 1 x COM
◆ Expansion Slots	5 slots
◆ Indicators	Power, HDD
◆ Buttons	Power switch, reset
◆ Operating Temperature	0~50°C
◆ Operation Humidity	10% ~ 90%
◆ Color	W: White
◆ Weight (Net/Gross)	3.8kg / 5.6kg
◆ Dimensions (DxWxH)	269mm x 140mm x 230.5mm

Backplane Options

Model No.	SBC Type	PCI	ISA	PCIe			PSU Connector
				x1	x4	x16	
BP-4S-RS-R30	ISA	0	4	0	0	0	AT
IP-4S-RS-R30	PCISA	3	0	0	0	0	AT
IP-4S2-RS-R30	PCISA	2	1	0	0	0	AT
IP-4SA-RS-R30	PCISA	3	0	0	0	0	ATX
IP-4S2A-RS-R30	PCISA	3	0	0	0	0	ATX
HPE-4S1	PCI/PIC0e	3	0	0	0	0	ATX
HPE-4S2	PCI/PIC0e	2	0	0	1	0	ATX

Ordering Information

Part No.	Description
PAC-400GW/ACE-916AP	5-slot half-size chassis, white, with ACE-916AP-RS, RoHS
PAC-400GW/ACE-816AP	5-slot half-size chassis, white, with ACE-816AP-RS, RoHS
PAC-400GW/ACE-4518AP	5-slot half-size chassis, white, with ACE-4518AP-RS, RoHS
7G000-BA1110-RS	3.5" IDE removable drive bay, white, RoHS
7G000-ST1110-RS	3.5" SATA removable drive bay, white, RoHS

Power Supply Options

Type	Model No.	Watt
AT	ACE-916AP-RS	150W
	ACE-816AP-RS	150W
ATX	ACE-816AP-RS	150W
	ACE-4518AP-RS	180W

PAC-400G can support single 1U height PSU. For more models of IEI PSU, please visit www.ieiworld.com.

PAC-52G

6-slot Half-size Compact Chassis

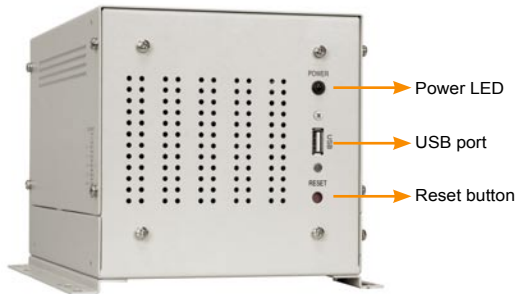

For low power system application only.

Features

- ◆ RoHS compliant design
- ◆ 1 x USB port on front panel
- ◆ 5-pin terminal block for 5V/12V DC input



1. I/O bracket with 40-pin and 34-pin ribbon cables
2. I/O cable without cables

Dimensions

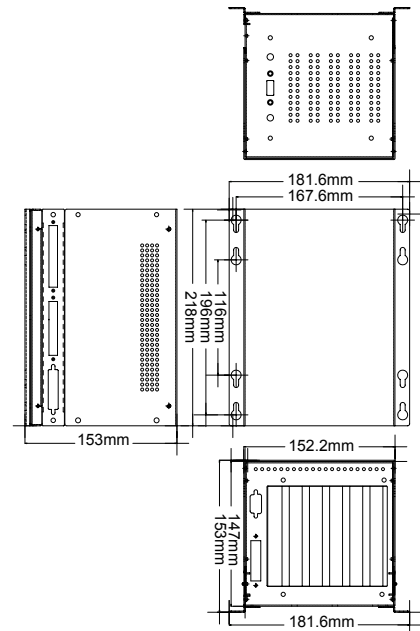

Specifications

◆ Construction	Heavy duty metal
◆ SBC Form Factor	Half-size, slot CPU cards
◆ I/O ports	1 x USB
◆ I/O openings	1 x COM
◆ Expansion Slots	6 slots
◆ Indicators	Power
◆ Buttons	reset
◆ Operating Temperature	0~50°C
◆ Operation Humidity	10% ~ 90%
◆ Color	W: White
◆ Weight (Net/Gross)	2kg / 3.4kg
◆ Dimensions (DxWxH)	218mm x 152.2mm x 147mm

Ordering Information

Part No.	Description
PAC-52GW/BP-6S	6-slot half-size chassis, white, with BP-6S-RS-R30, RoHS
PAC-52GW/IP-6S	6-slot half-size chassis, white, with IP-6S-RS-R30, RoHS
PAC-52GW/IP-5S2	6-slot half-size chassis, white, with IP-5S2-RS-R30, RoHS

Backplane Options

Model No.	SBC Type	PCI	ISA	PCIe			PSU Connector
				x1	x4	x16	
BP-6S-RS-R30	ISA	0	6	0	0	0	AT
IP-6S-RS-R30	PCISA	3	2	0	0	0	AT
IP-5S2-RS-R30	PCISA	4	0	0	0	0	AT
HPE-6S1	PCI/PICoE	4	0	0	1	0	ATX
HPE-6S2	PCI/PICoE	3	0	2	0	0	ATX

PAC-700G

7-slot Half-size Compact Chassis

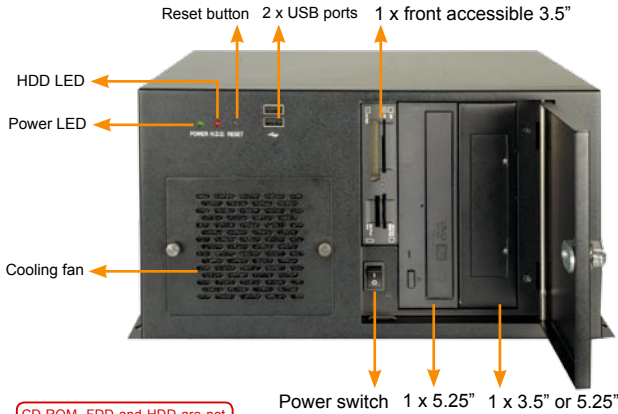

CD-ROM, FDD and HDD are not included in package



Features

- ◆ RoHS compliant design
- ◆ 2 x USB ports on front panel
- ◆ 1 x 8 cm cooling fan with fan filter
- ◆ Easy accessible design for fan replacement

Easy hot-replaceable fan



- Step 1: Loosen the thumb screws
- Step 2: Pull the fan out gently
- Step 3: Unplug the power connector

Dimensions

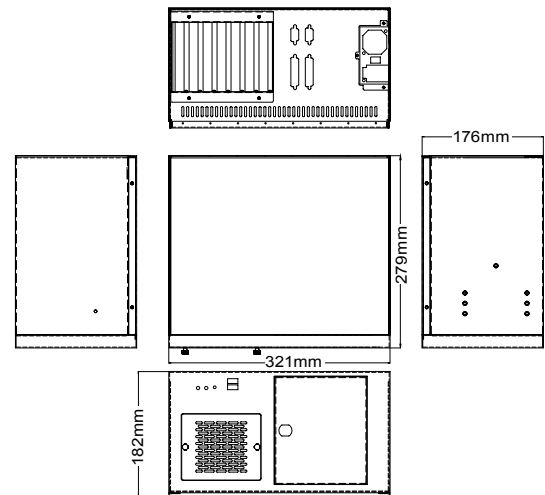

Backplane Options

Model No.	SBC Type	PCI	ISA	PCIe			PSU Connector
				x1	x4	x16	
BP-7S-RS-R30	ISA	0	7	0	0	0	AT
IP-7S-RS-R30	PCISA	4	2	0	0	0	AT
IP-7SA-RS-R30	PCISA	4	2	0	0	0	ATX
HPE-7S1	PCI/PIC0e	4	0	2	0	0	ATX

Power Supply Options

Type	Model No.	Watt
AT	ACE-916AP-RS	150W
	ACE-816AP-RS	150W
ATX	ACE-4518AP-RS	180W

PAC-700G can support single 1U height PSU. For more models of IEI PSU, please visit www.ieiworld.com

Specifications

◆ Construction	Heavy duty metal
◆ SBC Form Factor	Half-size, slot CPU card
◆ Drive Combinations	2 x 5.25" + 1 x front accessible 3.5" or 1 x 5.25" + 2 x front accessible 3.5" or 1 x 5.25" + 1 x front accessible 3.5" + 1 x 3.5" HDD
◆ Cooling Fans	1 x 8cm
◆ I/O ports	2 x USB on front panel
◆ I/O openings	2 x LPT, 2 x COM
◆ Expansion Slots	7 slots
◆ Indicators	Power, HDD
◆ Buttons	power switch, reset
◆ Operating Temperature	0~50°C
◆ Operation Humidity	10% ~ 90%
◆ Color	B: Black
◆ Weight (Net/ Gross)	6.2kg / 9kg
◆ Dimension (DxWxH)	279mm x 321mm x 176mm

Ordering Information

Part No.	Description
PAC-700GB/BP-7S/ACE-916AP	7-slot half-size chassis, with BP-7S-RS-R30 and ACE-916AP-RS
PAC-700GB/IP-7S/ACE-916AP	7-slot half-size chassis, with IP-7S-RS-R30 and ACE-916AP-RS
PAC-700GB/IP-7SA/ACE-816AP	7-slot half-size chassis, with IP-7SA-RS-R30 and ACE-816AP-RS

EBC-1000G

Embedded Chassis for WAFER Series SBC



EBC-1000G with WAFER-C400-RS and BK-C400-RS

Features

- ◆ RoHS compliant design
- ◆ 1 x 2.5" HDD drive capacity
- ◆ 1 x 4cm cooling fan
- ◆ AC/DC power supply compatible



BK-LX800-RS



BK-C400-RS



BK-9371-RS



BK-6612-RS

SBC model	WAFER-C400-RS	WAFER-9371A	WAFER-6612	WAFER-LUKE	WAFER-MARK	WAFER-LX	WAFER-GX
Picture							
CPU	ULV Intel® Celeron® 400MHz	ULV Intel® Celeron® 400/650MHz	Intel® Pentium® M/Celeron® M CPU	VIA® LUKE 1GHz/533MHz	VIA® MARK 533/800MHz	AMD® Geode LX800 500MHz	AMD® Geode GX466 333MHz
I/O Bracket	BK-C400-RS	BK-9371-RS	BK-6612-RS	BK-LX800-RS	BK-LX800-RS	BK-LX800-RS	BK-LX800-RS

Specifications

◆ Construction	Heavy duty metal
◆ SBC Form Factor	3.5" WAFER series SBC
◆ Drive Bays	1 x 2.5" HDD
◆ Cooling Fans	1 x 4 cm
◆ Indicators	Power, HDD
◆ Buttons	Power switch
◆ Operating Temperature	0~50°C
◆ Operation Humidity	10% ~ 90%
◆ Color	B: Black
◆ Weight (Net/Gross)	1.2kg / 2.2kg
◆ Dimensions (DxWxH)	130mm x 172.2mm x 116mm

Dimensions

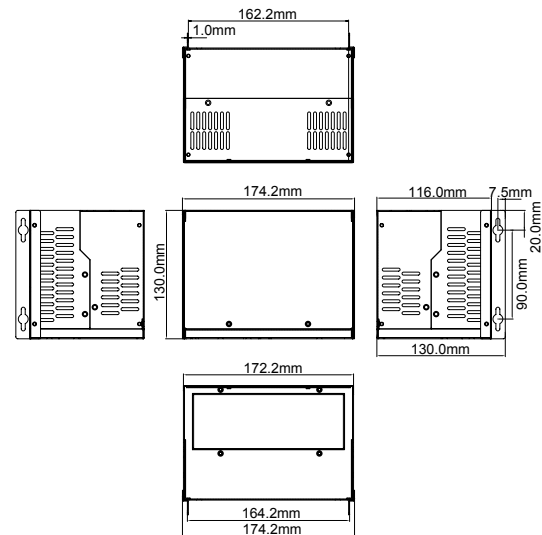

Ordering Information

Part No.	Description
EBC-1000GB/ACE-890AP	Industrial embedded chassis for WAFER series SBC, black, with ACE-890AP-RS, RoHS
BK-C400-RS	I/O bracket for WAFER-C400-RS, black, RoHS
BK-9371-RS	I/O bracket for WAFER-9371A, black, RoHS
BK-6612-RS	I/O bracket for WAFER-6612, black, RoHS
BK-LX800-RS	I/O bracket for WAFER-LX/GX/LUKE/MARK, black, RoHS

Power Supply Options

Type	Model No.	Input Type	Watt
AT	ACE-890A-RS	AC	86W
	ACE-890AP-R20-RS	AC	86W
	ACE-890V-RS	DC 12V	72W
	ACE-890C-RS	DC 24V	86W
	ACE-890T-RS	DC 48V	86W
	ACE-890P-RS	DC 100V	86W

EBC-2100



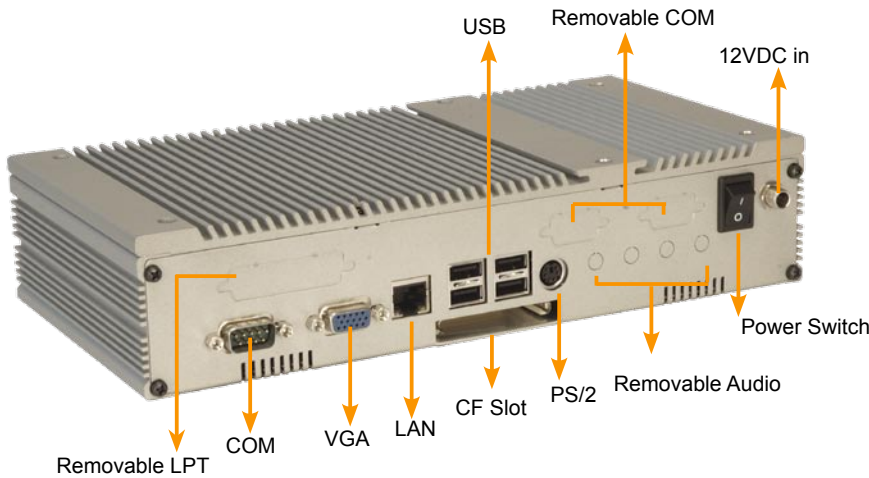

Embedded Chassis for EPIC NANO Series



Support EPIC NANO model

NANO-7240 series
 NANO-8522 series
 NANO-GX
 NANO-LX

Support EPIC NANO model

NANO-7240-RS	NANO-8522G	NANO-8522E-800Z	NANO-GX	NANO-LX
<i>Fanless</i> 			<i>Fanless</i> 	<i>Fanless</i> 
ULV Intel® Celeron® 400MHz	Socket 479 base Intel® Pentium M/Celeron® M CPU	ULV Intel® Celeron® M 1G/800MHz CPU without L2 cache	AMD® GX466 333MHz	AMD® LX800 500MHz

Specifications

◆ I/O	Standard I/O	COM x 1, VGA x 1, LAN x 1, CF x 1, PS/2 x 1, USB x 4
	Expansion I/O	COM x 2 Audio x 1 (line-in, Line-out, Mic-in, spk-out) LPT x 1
◆ Internal Drive Bay		2.5" HDD x 1
◆ Expansion slot		Internal space for PC/104 or PC/104 Plus module
◆ Color		Pantone Gray 7C
◆ Material		Aluminum / SECC
◆ Operation Temperature		0~50°C
◆ Operation Humidity		10% to 90%
◆ Weight (Net/ Gross)		1 kg / 3 kg
◆ Dimension (DxWxH)		134mm x 262mm x 56mm

Dimensions

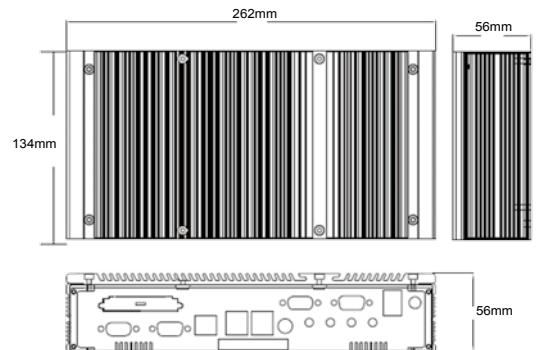

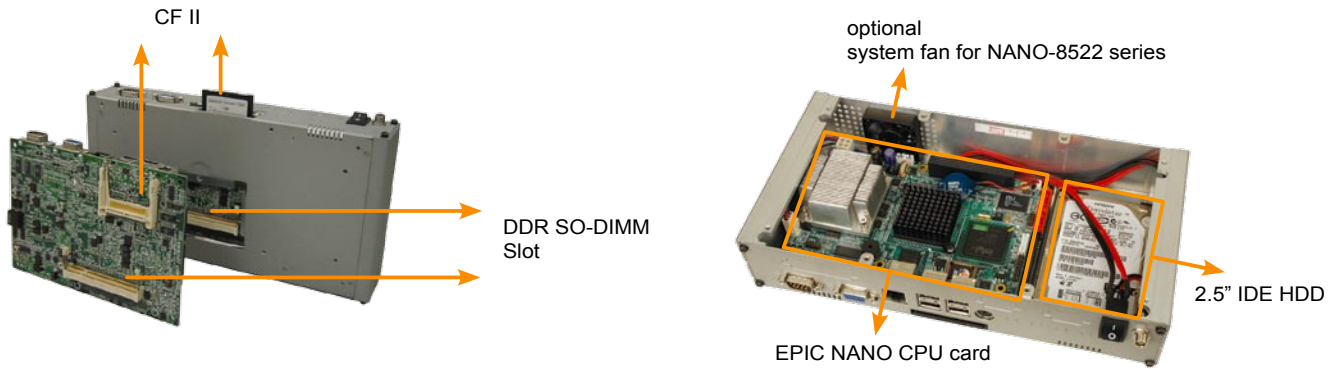

Optional Peripherals



Socket type CPU Heatsink Module
P/N: 34000-000101-RS

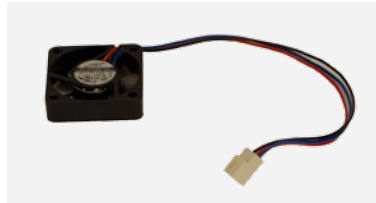

40mm Cooling Fan Module
P/N: 19100-000027-RS

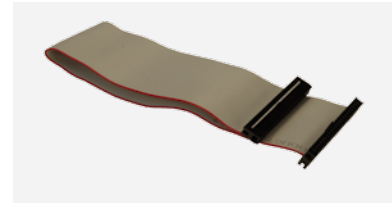

44 pin IDE cable for 2.5" HDD
P/N: 32200-000037-RS

Recommendation of System Cooling Components

● Must-have ○ Recommended

Board Model code	CPU	EPIC NANO Board Companion Heatsink	Optional Heatsink P/N: 34000-000101-RS	Optional Cooling Fan P/N: 19100-000027-RS
NANO-7240-RS	ULV Intel® Celeron® 400MHz	●		○
NANO-8522G	Socket 479 base Intel® Pentium® M/ Celeron® M CPU up to 1.8GHz		●	●
NANO-8522E-800Z	ULV Intel® Celeron® M 1G/800MHz with 512K L2 cache	●		○
NANO-GX	AMD® GX466 333MHz	●		
NANO-LX	AMD® LX800 500MHz	●		

Packing List



- 1 x EBC-2100 Chassis
- 1 x QIG
- 1 x Screws set
- 2 x Wall mounting kits
- 4 x Rubber foot pad
- 1 x Power adaptor
- 1 x Power cord

Ordering Information

Part No.	Description
EBC-2100-R10	Embedded chassis for NANO-7240-RS, RoHS
EBC-2100-R11	Embedded chassis for NANO-8522G/8522E/GX/LX, RoHS
34000-000101-RS	Optional socket type CPU heatsink module
19100-000027-RS	Optional 40mm, +12V ball bearing cooling fan
32200-000037-RS	44 pin IDE cable for 2.5" hard drive