

Selection Guide

Industrial Chassis



Model Name	MK-100	MK-110 / MK-110-A	RK-110S / RK-110SE	RK-210S / RK-210E	RK-220 / RK-220E
Type	Standalone/Wallmount	Standalone/Wallmount	Rackmount	Rackmount	Rackmount
Height	3.5" (88mm)	6.1" (156mm)	1U	2U	2U
Depth	10.7" (232mm)	9.5" (241mm)	17.7" (450mm)	17.7" (450mm)	25.6" (650mm)
Backplane Options	MI-110 MI-960 MI-965	MI-110 MI-110 MI-960 MI-965 MI-965	HPCI-D3S2 EBP-D3E1 EBP-D3S1	HPCI-D6S4 EBP-D5E2	HPCI-D6S4 EBP-D5E2
Page Number	7-2	7-3	7-4	7-5	7-6



Model Name	RK-260 / RK-260MB	RK-410FS	RK-440	RK-460 / RK-460MB	RK-610A / RK-610MB
Type	Rackmount	Rackmount	Rackmount	Rackmount	Rackmount
Height	2U	4U	4U	4U	4U
Depth	17.7" (450mm)	17.8" (451mm)	26.4" (671mm)	17.8" (451mm)	17.8" (451mm)
Backplane Options	HPCI-D6S4 ATX motherboard	EBP-10E5 EBP-13E4 HPCI-13S4LU HPCI-14S7U HPCI-14S12U HPCI-14S/ATX	HPCI-19S18A	EBP-10E5, EBP-13E4 HPCI-13S4LU HPCI-14S7U HPCI-14S12U HPCI-14S/ATX ATX motherboard	EBP-10E5, EBP-13E4 HPCI-13S4LU HPCI-14S7U HPCI-14S12U HPCI-14S/ATX ATX motherboard
Page Number	7-7	7-8	7-9	7-10	7-11



Model Name	RK-615FB	RK-604A	RK-606UC	RK-607B	RK-608B / RK-608MB
Type	Rackmount	Standalone/Wallmount	Standalone/Wallmount	Standalone/Wallmount	Standalone/Wallmount
Height	4U	10.2" (260mm)	9.7" (246.5mm)	6.9" (175mm)	6.9" (175mm) / 7.7" (196mm)
Depth	20.1" (510mm)	9.8" (248mm)	16.2" (412mm)	16.5" (418mm)	16.5" (418mm) / 16" (406mm)
Backplane Options	EBP-10E5 EBP-13E4 HPCI-15S HPCI-15S10 HPCI-13S4LU HPCI-14S7U HPCI-14S12U HPCI-14S/ATX	HPM-4S	EBP-5E1 HPCI-6S4	EBP-5E1 HPCI-6S4	HPCI-8S4 HPCI-9S7U EBP-7E2 EBP-9E2 ATX motherboard
Page Number	7-12	7-13	7-14	7-15	7-16 / 7-17

MK-100

Embedded Chassis for Mini-ITX Motherboard



Features

- Front I/O interface
- Shock-resistant bay space for 3.5" disk drive
- Cutouts for two COM, one DVI/LVDS, one S/C-video
- Supports both AC(180W) and DC(200W) ATX PFC power supply options
- Reusable and washable air filter
- LED indicators for system power and HDD

Specifications

Dimensions	9.1 in x 3.5 in x 10.7 in (272 mm x 88 mm x 232 mm) (W x H x D)
Drive Bays	One 3.5" HDD internal drive bay
Construction	Heavy-duty steel
Color	Standard: gray
Cooling Fans	One 60 mm x 60 mm x 15 mm ball bearing fans
Front Panel	LEDs: HDD activity and system power System reset switch and ATX power switch Supports ATX power supply
Carton Size	15.5 in x 14.6 in x 8.5 in (395 mm x 375 mm x 215 mm)
Weight	Net 2 kg (4.4 lb)

Power Supply Options

Model Number	Watt	Input Range	Output (Max.)					Type	
			+5V	+3.3V	+12V	-12V	-5V		+5Vsb
APS-918XU	180 W	100 – 240 VAC	16A	14A	14 A	0.5 A	-	2 A	ATX

Ordering Information

Model Number	Color	Power Supply
NS-100MI-180	Gray	APS-918XU

Mechanical Layout



Dimensions

Units: mm

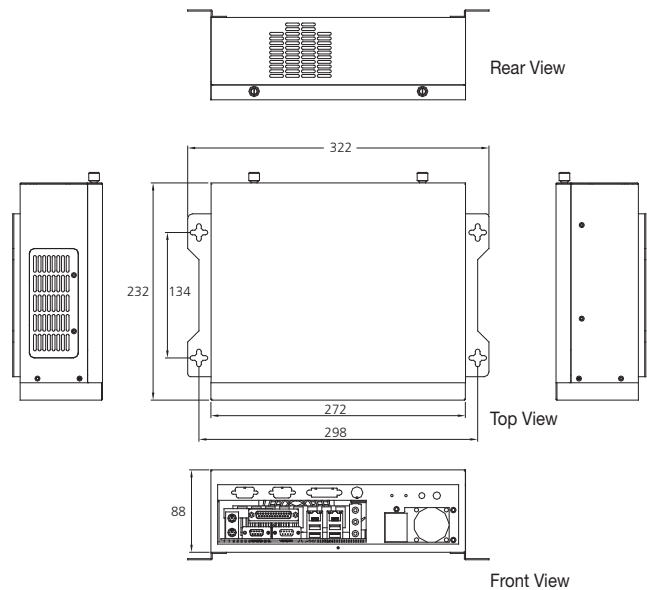

MK-110, MK-110-A Embedded Chassis for Mini-ITX Motherboard with One/Two Expansion Slots



Features

- Front I/O interface
- Shock-resistant bay space for one slim-type optical drive and 3.5" disk drive
- Cutouts for three COM, two DVI/LVDS, one S/C-video
- Supports both AC(180W) and DC(200W) ATX PFC power supply options
- Reusable and washable air filter
- MK-110 supports one expansion slot, MK-110-A supports two expansion slots

Specifications

Dimensions	9.8 in x 6.1 in x 10 in (250 mm x 156 mm x 241 mm) (W x H x D)
Drive Bays	One 3.5" HDD internal drive bays One slim-type CD/DVD-ROM
Construction	Heavy-duty steel
Color	Standard: gray
Cooling Fans	One 92 mm x 92 mm x 25 mm ball bearing fan
Front Panel	LEDs: HDD activity and system power System reset switch and ATX power switch Supports ATX power supply
Carton Size	15.5 in x 14.6 in x 10.8 in (395 mm x 375 mm x 275 mm)
Weight	Net 3 kg (6.6 lb)

Power Supply Options

Model Number	Watt	Input Range	Output (Max.)						Type
			+5V	+3.3V	+12V	-12V	-5V	+5Vsb	
APS-918XU	180 W	100 – 240 VAC	16A	14A	14A	0.5A	-	2A	ATX

Ordering Information

Model Number	Color	Power Supply
MK-110		
NS-110MI-180	Gray	APS-918XU
MK-110-A		
NS-110AMI-180	Gray	APS-918XU

Mechanical Layout



MK-110



MK-110-A



Dimensions

Units: mm

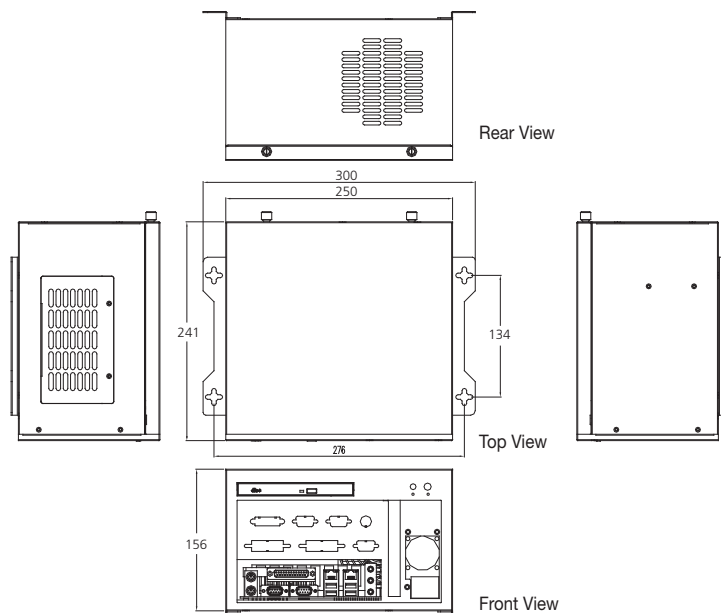

RK-110S, RK-110SE 1U Rackmount Industrial Chassis with 3-slot Backplane



Features

- 1U height, 17.7 inch (450 mm) short depth
- One slim FDD & one slim-type optical drive bay
- One rear PCI expansion slot, integrated 250 W - 300 W power supply
- Supports PICMG 1.0 backplane (RK-110S) and PICMG 1.3 backplane (RK-110SE)

Specifications

Dimensions	19 in x 1.75 in x 17.7 in (483 mm x 44 mm x 450 mm) (W x H x D)
Drive Bays	One 5.25" bay for slim-type optical drive and 3.5" HDD One 3.5" bay for slim-type FDD
Construction	Heavy-duty steel
Color	Standard: black
Cooling Fans	Three 4 cm ball bearing fans, 7.0 CFM each, two front and one rear
Front Panel	Easy-to-customize front door LEDs: HDD activity, system power System reset switch, ATX power switch
Rear Panel	Two USB 1.1/2.0 connectors, PS/2 keyboard connector
Carton Size	23.4 in x 6 in x 22.8 in (594 mm x 152 mm x 578 mm)
Weight	Net 12 kg (26.4 lb)

Mechanical Layout



Backplane Options

Model Number	PICMG® SBC	PCI	PCIe x4	PSU Connector
HPCI-D3S2	1	2	-	ATX
EBP-D3E1	1	-	1	ATX

Power Supply Options

Model Number	Watt	Input Range	Output (Max.)					Type	
			+5V	+3.3V	+12V	-12V	-5V		+5Vsb
APS-9125XU	250 W	90 – 264 VAC Full Range	25 A	14 A	12 A	1 A	0.5 A	1.5 A	ATX12V
APS-9130XU	300 W	90 – 264 VAC Full Range	24 A	20 A	20 A	0.5 A	0.5 A	1.5 A	ATX12V

Ordering Information

Model Number	Color	Backplane	Power Supply
NS-110SB-D3S2-250	Black	HPCI-D3S2	APS-9125XU
NS-110E-D3E1-250	Black	EBP-D3E1	APS-9125XU

Dimensions

Units: mm

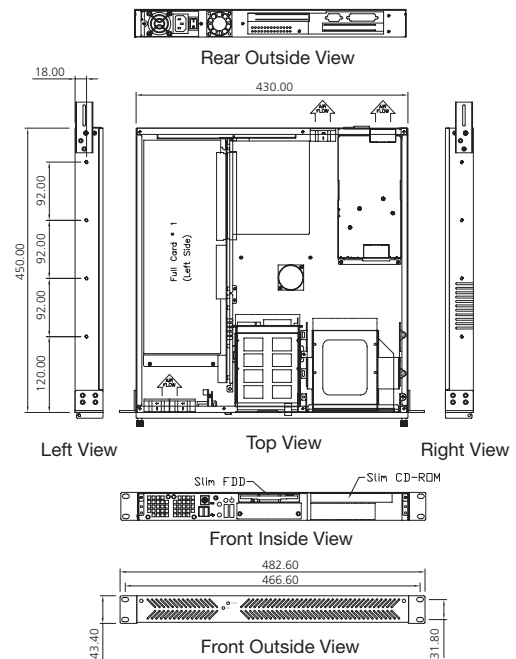

RK-210S, RK-210E

2U Rackmount Industrial Chassis with 6-slot Backplane



Features

- EIA RS-310C 19" Rackmount Standard
- Supports PICMG® 1.0 backplane (RK-210S) and PICMG® 1.3 backplane (RK-210E)
- Short depth chassis for space savings
- Bay space for one 5.25" and one 3.5" drive bay
- Removable air filter

Specifications

Dimensions	19 in x 3.5 in x 17.7 in (483 mm x 88 mm x 450 mm) (W x H x D)
Drive Bays	One 5.25" bay space for slim type optical drive and internal 3.5" device, one external 3.5" drive bay
Construction	Heavy-duty steel
Color	Standard: black
Cooling Fans	Three 8-cm ball bearing fans, 42.5 CFM each
Front Panel	Easy-to-customize front door LEDs: HDD active, system power System reset switch, ATX Power switch Two USB connectors, PS/2 keyboard connector
Backplane	6-slot PICMG® 1.0 backplane (RK-210S) 5-slot PICMG® 1.3 backplane (RK-210E)
Carton Size	24.2 in x 8.8 in x 23.6 in (615 mm x 224 mm x 600 mm)
Weight	Net 15 kg (33 lb)

Power Supply Options

Model Number	Watt	Input Range	Output (Max.)					Type	
			+5V	+3.3V	+12V	-12V	-5V		+5Vsb
APS-935XA-EPS12	350 W	90 – 264 VAC Full Range	35 A	28 A	26 A	0.8 A	0.5 A	2 A	EPS12V
APS-940XA-EPS12	400 W	90 – 264 VAC Full Range	35 A	28 A	30 A	0.8 A	0.5 A	2 A	EPS12V
APS-946XA-EPS12	460 W	90 – 264 VAC Full Range	40 A	30 A	32 A	1 A	0.8 A	2 A	EPS12V

Ordering Information

Model Number	Color	Backplane	Power Supply
NS-210SB-D6S4-350	Black	HPCI-D6S4	APS-935XA-EPS12
NS-210E-D5E2-350	Black	EBP-D5E2	APS-935XA-EPS12

Backplane Options

Model Name	PICMG® SBC	PCIe x1	PCIe x4	PCIe x16	PCI	ISA	PSU Connector
HPCI-D6S4	1	--	--	--	4	1	ATX/AT
EBP-D5E2	1	--	1	1	2	--	ATX/AT

Mechanical Layout



Dimensions

Units: mm

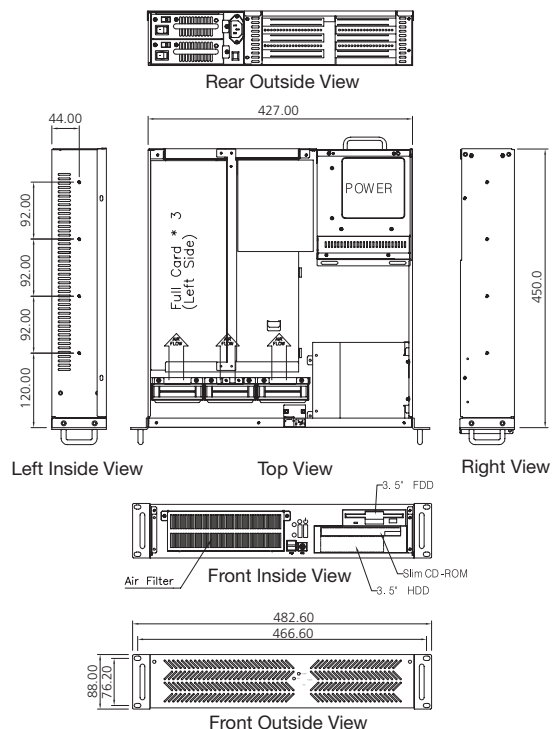

RK-220, RK-220E

2U Rackmount Industrial Chassis with 6-slot Backplane



Features

- EIA RS-310C 19" Rackmount Standard
- Supports PICMG® 1.0 backplane (RK-220) and PICMG® 1.3 backplane (RK-220E)
- Four 5.25", two 3.5" & one slim optical external drive bays
- Four 8-cm ball bearing fans, 42.5 CFM each
- Two front accessible USB connectors

Specifications

Dimensions	17 in x 3.5 in x 25.6 in (434 x 88.5 x 648.6 mm) (W x H x D)
Drive Bays	Four 5.25", two 3.5" & one slim optical external drive bays
Construction	Heavy-duty steel
Color	Standard: black
Cooling Fans	Four 8-cm ball bearing fans, 42.5 CFM each
Front Panel	LEDs: HDD active, system power System reset switch, ATX power switch Two USB connectors, PS/2 keyboard connector
Backplane	6-slot PICMG 1.0 backplane (RK-220) 5-slot PICMG 1.3 backplane (RK-220E)
Carton Size	21.8 in x 9.2 in x 29.7 in (555 mm x 235 mm x 755 mm)
Weight	Net 16.5 kg(36.3 lb)

Backplane Options

Model Name	PICMG® SBC	PCIe x1	PCIe x4	PCIe x16	PCI	ISA	PSU Connector
HPCI-D6S4	1	--	--	--	4	1	ATX/AT
EBP-D5E2	1	--	1	1	2	--	ATX/AT

Mechanical Layout



Power Supply Options

Model Number	Watt	Input Range	Output (Max.)					Type	
			+5V	+3.3V	+12V	-12V	-5V		+5Vsb
APS-935XA-EPS12	350 W	90 – 264 VAC Full Range	35 A	28 A	26 A	0.8 A	0.5 A	2 A	EPS12V
APS-940XA-EPS12	400 W	90 – 264 VAC Full Range	35 A	28 A	30 A	0.8 A	0.5 A	2 A	EPS12V
APS-946XA-EPS12	460 W	90 – 264 VAC Full Range	40 A	30 A	32 A	1 A	0.8 A	2 A	EPS12V

Ordering Information

Model Number	Color	Backplane	Power Supply
NS-220B-D6S4-400	Black	HPCI-D6S4	APS-940XA-EPS12
NS-220E-D5E2-400	Black	EBP-D5E2	APS-940XA-EPS12

Dimensions

Units: mm

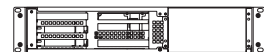

Rear View

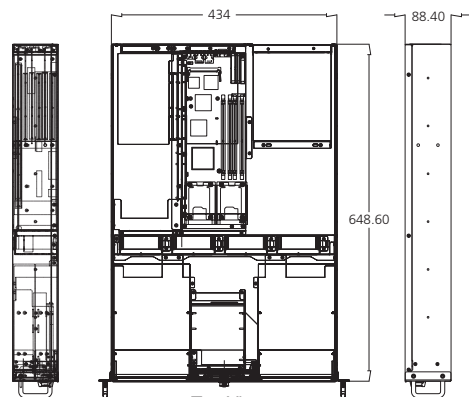

Top View



Front Inside View



Front Outside View

RK-260, RK-260MB

2U Rackmount Chassis Supporting 6-slot Backplane and Motherboard



Features

- EIA RS-310C 19" Rackmount Standard
- Two 5.25" drive bays
- 6-slot backplane (RK-260) and ATX motherboard (RK-260MB)
- PS2 ATX or mini redundant power supply
- I/O shield rear panel opening for motherboard version
- Replaceable and easy-to-clean air filter
- Front mounted fan module for easy maintenance

Specifications

Dimensions	16.8 in x 3.5 in x 18.1 in (427 mm x 88.8 mm x 460 mm) (W x H x D)
Drive Bays	Two 5.25" drive bays (with one slim optical drive + FDD converter)
Construction	Heavy-duty steel
Color	Standard: black
Cooling Fans	Two 60 x 60 x 20 mm ball bearing fans (push cooling)
Front Panel	Two USB connectors ATX power switch PS/2 keyboard connector
Power Supply	PS2 form factor ATX or mini redundant power supply (RK-260 only)
Carton Size	24.2 in x 22 in x 9.1 in (615 mm x 560 mm x 232 mm)
Weight	Net 15 kg (33 lb)

Backplane Options

Model Number	PICMG® SBC	PCI	ISA	PSU Connector
HPCI-D6S4	1	4	1	ATX/AT

Mechanical Layout



RK-260

RK-260MB

Power Supply Options

Model Number	Watt	Input Range	Output (Max.)					Type	
			+5V	+3.3V	+12V	-12V	-5V		+5Vsb
For RK-260									
APS-935XA-EPS12	350 W	90 – 264 VAC Full Range	35 A	28 A	26 A	0.8 A	0.5 A	2 A	EPS12V
APS-940XA-EPS12	400 W	90 – 264 VAC Full Range	35 A	28 A	30 A	0.8 A	0.5 A	2 A	EPS12V
APS-946XA-EPS12	460 W	90 – 264 VAC Full Range	40 A	30 A	32 A	1 A	0.8 A	2 A	EPS12V
For RK-260MB									
APS-935XA-EPS12/P2H-6350P	350 W	90 – 264 VAC Full Range	25 A	25 A	40 A	0.8 A	0.8 A	3.5 A	EPS12V

Ordering Information

Model Number	Color	Backplane	Power Supply
NS-260B-D6S4-350	Black	HPCI-D6S4	APS-935XA-EPS12
NS-260MBB-350	Black	—	APS-935XA-EPS12/ P2H-6350P

Dimensions

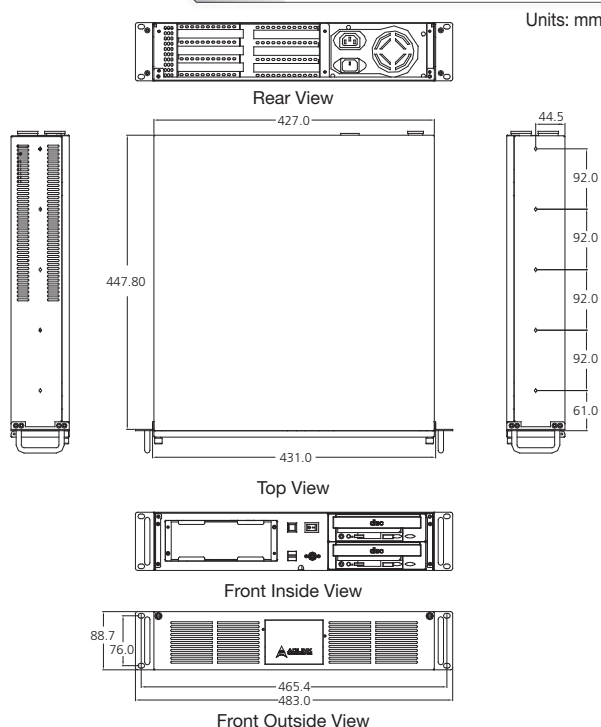

RK-410FS

4U Rackmount Industrial Chassis with 14-slot Backplane



Features

- EIA RS-310C 19" rackmount standard
- 17.8 inch (451 mm) short depth
- Three 5.25" and one 3.5" shock-resistant drive bays
- Two front accessible USB connectors
- Adjustable hold down bar for cards
- Supports various backplanes and power supply units

Specifications

Dimensions	19 in x 7 in x 17.8 in (483 mm x 177 mm x 451 mm) (W x H x D)
Drive Bays	Three 5.25" and one 3.5" front accessible drive bays
Construction	Heavy-duty steel
Color	Standard: beige
Cooling Fans	Two 9 cm ball bearing fans, 51 CFM each
Front Panel	Front door with lock Two front accessible USB connectors LEDs: HDD active and system power System reset switch, ATX power switch
Backplane	Supports 14-slot passive backplanes
Power Supply	Supports PS2 form factor AT, ATX power supply unit
Carton Size	23.6 in x 13.6 in x 25.2 in (600 mm x 345 mm x 640 mm)
Weight	Net 18 kg (39.6 lb)

Backplane Options

Model Name	PICMG® SBC	PCIe x1	PCIe x4	PCIe x16	PCI	ISA	PSU Connector
EBP-10E5	1	4	--	1	4	--	ATX
EBP-13E4	1	--	3	1	7	--	ATX
HPCI-13S4LU	3	--	--	--	4	7	ATX/AT
HPCI-14S7U	3	--	--	--	7	5	ATX/AT
HPCI-14S12U	2	--	--	--	12	1	ATX/AT
HPCI-14S/ATX	2	--	--	--	4	8	ATX/AT

Mechanical Layout



Power Supply Options

Model Number	Watt	Input Range	Output (Max.)						Type
			+5V	+3.3V	+12V	-12V	-5V	+5Vsb	
APS-935XA-EPS12	360 W	90 – 264 VAC Full Range	35 A	28 A	26 A	0.8 A	0.5 A	2 A	EPS12V
APS-940XA-EPS12	400 W	90 – 264 VAC Full Range	35 A	28 A	30 A	0.8 A	0.5 A	2 A	EPS12V
APS-946XA-EPS12	460 W	90 – 264 VAC Full Range	40 A	30 A	32 A	1 A	0.8 A	2 A	EPS12V

Ordering Information

Model Number	Color	Backplane	Power Supply
NS-410FS-14S7U-350	Beige	HPCI-14S7U	APS-935XA-EPS12
NS-410FS-14S12U-400	Beige	HPCI-14S12U	APS-940XA-EPS12
NS-410FS-10E5-350	Beige	EBP-10E5	APS-935XA-EPS12
NS-410FS-13E4-350	Beige	EBP-13E4	APS-935XA-EPS12

Dimensions

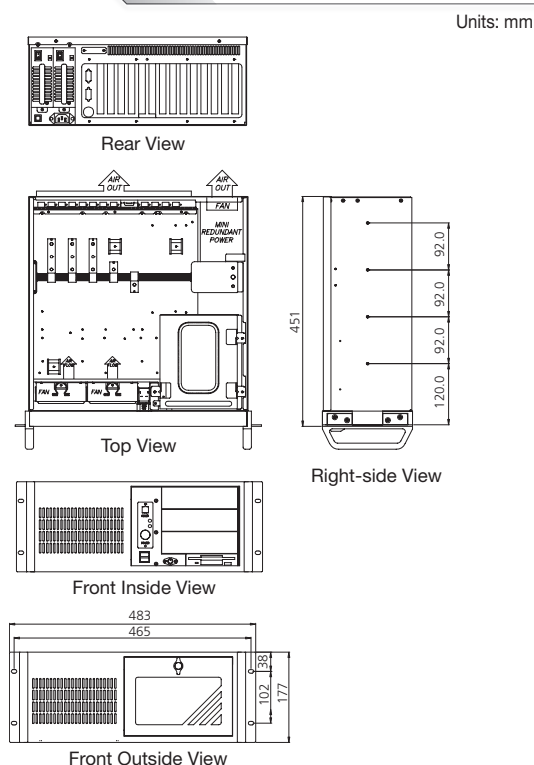



Features

- EIA RS-310C 19" rackmount standard
- Supports 19-slot backplane and dual redundant power supply
- Three 5.25" and one 3.5" shock-resistant drive bays
- Adjustable hold down bar for cards

Specifications

Dimensions	19 in x 7 in x 26.4 in (480 mm x 177 mm x 671 mm) (W x H x D)
Drive Bays	Three 5.25" and one 3.5" front accessible drive bays
Construction	Heavy-duty steel
Color	Standard: black
Cooling Fans	Four 9-cm ball bearing fans, 51 CFM each
Front Panel	Front door with lock LEDs: HDD active, system power System reset switch, ATX power switch
Backplane	Support 19-slot passive backplane
Carton Size	33.5 in x 24.4 in x 13.6 in (850 mm x 620 mm x 345 mm)
Weight	Net 24.5 kg (53.9 lb)

Backplane Options

Model Number	PICMG® SBC	PCI	ISA	PSU Connector
HPCI-19S18A	2	18	-	ATX/AT

Mechanical Layout



Power Supply Options

Model Number	Watt	Input Range	Output (Max.)					Type	
			+5V	+3.3V	+12V	-12V	-5V		+5Vsb
APS-6300F (Dual Redundant)	300 W	90 – 132 VAC	36 A	25 A	17 A	0.8 A	0.8 A	1 A	ATX/ ATX12V
APS-6400F (Dual Redundant)	400 W	180 – 264 VAC	36 A	25 A	17 A	0.8 A	0.8 A	1 A	ATX/ ATX12V

Ordering Information

Model Number	Color	Backplane	Power Supply
NS-440B-19S18A-R400	Black	HPCI-19S18A	APS-6400F

Dimensions

Units: mm

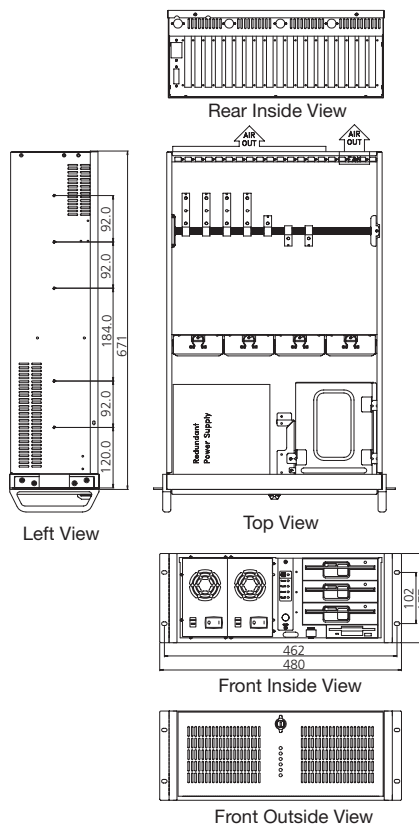

RK-460/460MB

4U Rackmount Chassis Supporting 14-slot Backplane and Motherboard



Features

- EIA RS-310C 19" Rackmount Standard
- Supports 14-slot backplane (RK-460) and ATX motherboard (RK-460MB)
- Three 5.25" external, one 3.5" external, and one internal 3.5" drive bays
- Two USB ports inside front door
- Replaceable and easy-to-clean air filter
- PS2 form factor ATX or mini redundant power supply
- I/O shield rear panel opening for motherboard version

Specifications

Dimensions	16.8 in x 7 in x 17.8 in (426.5 mm x 177 mm x 451 mm) (W x H x D)
Drive Bays	Three 5.25" and one 3.5" front accessible drive bays One internal 3.5" drive bay
Construction	Heavy-duty steel
Color	Standard: black
Cooling Fans	One 120 mm x 120 mm x 25 mm ball bearing fan and one optional 80 mm x 80 mm x 25mm fan (push cooling)
Front Panel	Front door with lock, two USB connector System reset switch, ATX power switch and keyboard lock switch
Backplane	14-slot passive backplane (RK-460) microATX & ATX motherboard (RK-460MB)
Power Supply	Supports PS2 form factor ATX power supply
Carton Size	24.8 in x 13 in x 21.9 in (630 mm x 330 mm x 555 mm)
Weight	Net 18 kg (39.6 lb)

Backplane Options

Model Name	PICMG® SBC	PCIe x1	PCIe x4	PCIe x16	PCI	ISA	PSU Connector
EBP-10E5	1	4	--	1	4	--	ATX
EBP-13E4	1	--	3	1	7	--	ATX
HPCI-13S4LU	3	--	--	--	4	7	ATX/AT
HPCI-14S7U	3	--	--	--	7	5	ATX/AT
HPCI-14S12U	2	--	--	--	12	1	ATX/AT
HPCI-14S/ATX	2	--	--	--	4	8	ATX/AT

Mechanical Layout



Power Supply Options

Model Number	Watt	Input Range	Output (Max.)					Type	
			+5V	+3.3V	+12V	-12V	-5V		+5Vsb
APS-935XA-EPS12	350 W	90 – 264 VAC Full Range	35 A	28 A	26 A	0.8 A	0.5 A	2 A	EPS12V
APS-940XA-EPS12	400 W	90 – 264 VAC Full Range	35 A	28 A	30 A	0.8 A	0.5 A	2 A	EPS12V
APS-946XA-EPS12	460 W	90 – 264 VAC Full Range	40 A	30 A	32 A	1 A	0.8 A	2 A	EPS12V

Ordering Information

Model Number	Color	Backplane	Power Supply
NS-460B-14S7U-350	Black	HPCI-14S7U	APS-935XA-EPS12
NS-460MBB-350	Black	-	APS-935XA-EPS12

Dimensions

Units: mm

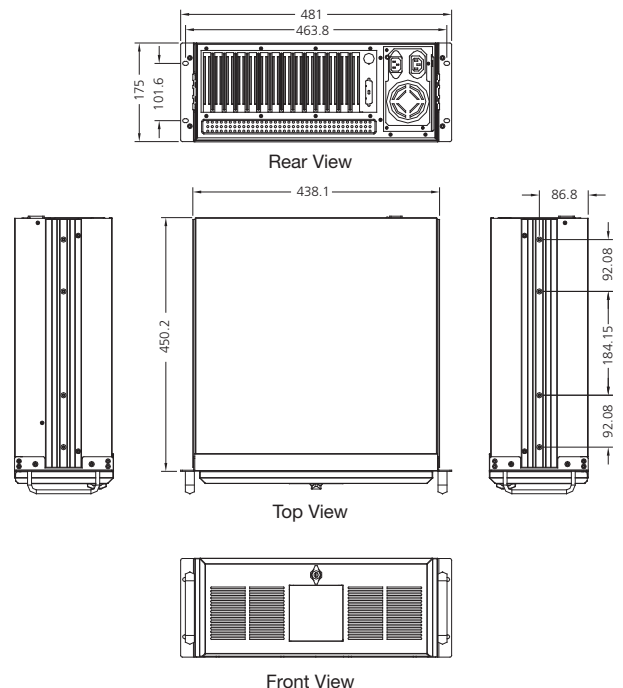

RK-610A, RK-610MB

4U Rackmount Chassis Supporting 14-slot Backplane and Motherboard



Features

- EIA RS-310C 19" Rackmount Standard
- Supports 14-slot backplane (RK-610A) and ATX motherboard (RK-610MB)
- Three 5.25" external, one 3.5" external, and one internal 3.5" drive bays
- Drive bay with shock and vibration resistant design
- Two USB ports inside front door
- Replaceable and easy to clean air filter
- PS2 ATX & mini redundant power supply

Specifications

Dimensions	16.8 in x 7 in x 17.8 in (426.5 mm x 177 mm x 451 mm) (W x H x D)
Drive Bays	Three 5.25" and one 3.5" front accessible drive bays One internal 3.5" drive bay
Construction	Heavy-duty steel
Color	Standard: beige and black
Cooling Fans	One 120 mm x 120 mm x 25 mm ball bearing fan and optional 80 mm x 80 mm x 25 mm fan (push cooling)
Front Panel	Front door with lock, two USB connectors LEDs: HDD active and system power System reset switch, ATX power switch and K/B lock switch
Backplane	14-slot passive backplane (RK-610A) microATX & ATX motherboards (RK-610MB)
Power Supply	PS2 form factor ATX power supply
Carton Size	24.8 in x 13 in x 21.9 in (630 mm x 330 mm x 555 mm)
Weight	Net 12 kg (26.4 lb)

Backplane Options

Model Name	PICMG® SBC	PCIe x1	PCIe x4	PCIe x16	PCI	ISA	PSU Connector
EBP-10E5	1	4	--	1	4	--	ATX
EBP-13E4	1	--	3	1	7	--	ATX
HPCI-13S4LU	3	--	--	--	4	7	ATX/AT
HPCI-14S7U	3	--	--	--	7	5	ATX/AT
HPCI-14S12U	2	--	--	--	12	1	ATX/AT
HPCI-14S/ATX	2	--	--	--	4	8	ATX/AT

Mechanical Layout



Power Supply Options

Model Number	Watt	Input Range	Output (Max.)						Type
			+5V	+3.3V	+12V	-12V	-5V	+5Vsb	
APS-935XA-EPS12	350 W	90 – 264 VAC Full Range	35 A	28 A	26 A	0.8 A	0.5 A	2 A	EPS12V
APS-940XA-EPS12	400 W	90 – 264 VAC Full Range	35 A	28 A	30 A	0.8 A	0.5 A	2 A	EPS12V
APS-946XA-EPS12	460 W	90 – 264 VAC Full Range	40 A	30 A	32 A	1 A	0.8 A	2 A	EPS12V

Ordering Information

Model Number	Color	Backplane	Power Supply
NS-610B-14S7U-350	Black	HPCI-14S7U	APS-935XA-EPS12
NS-610W-14S12U-400	Beige	HPCI-14S12U	APS-940XA-EPS12
NS-610W-10E5-350	Beige	EBP-10E5	APS-935XA-EPS12
NS-610W-13E4-350	Beige	EBP-13E4	APS-935XA-EPS12
NS-610MBB-350	Black	-	APS-935XA-EPS12
NS-610MBW-350	Beige	-	APS-935XA-EPS12

Dimensions

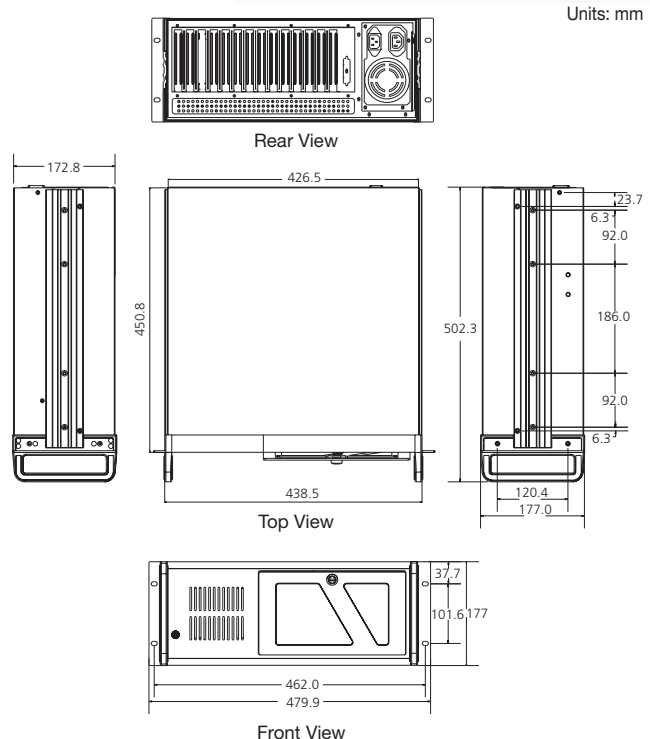

RK-615FB

4U Rackmount Industrial Chassis with 15-slot Backplane



Features

- Three 5.25-inch shock-resistant drive bays
- Easy-to-remove top cover
- Adjustable hold down bar for cards
- Supports AT or ATX power supply units
- Removable air filter
- Two front accessible USB connectors

Specifications

Dimensions	19 in x 7 in x 20.1 in (480 mm x 177 mm x 510 mm) (W x H x D)
Drive Bays	Three 5.25" front accessible drive bays Two optional racks for one 3.5" internal drive
Construction	Heavy-duty steel
Color	Standard: beige
Cooling Fans	One 12 cm ball bearing fan with 108 CFM, optional second fan
Front Panel	Front door with lock Two front accessible USB connectors LEDs: HDD active and system power System reset switch Power switch button
Backplane	14/15-slot passive backplane
Power Supply	PS2 form factor AT or ATX power supply unit
Carton Size	27.2 in x 23.6 in x 13.6 in (691 mm x 605 mm x 345 mm)
Weight	Net 19 kg (41.8 lb)

Power Supply Options

Model Number	Watt	Input Range	Output (Max.)					Type	
			+5V	+3.3V	+12V	-12V	-5V		+5Vsb
APS-935XA-EPS12	350 W	90 – 264 VAC Full Range	35 A	28 A	26 A	0.8 A	0.5 A	2 A	EPS12V
APS-940XA-EPS12	400 W	90 – 264 VAC Full Range	35 A	28 A	30 A	0.8 A	0.5 A	2 A	EPS12V

Ordering Information

Model Number	Color	Backplane	Power Supply
NS-615FB-15S-350	Beige	HPCI-15S	APS-935XA-EPS12
NS-615FB-15S10-400	Beige	HPCI-15S10	APS-940XA-EPS12

Dimensions

Units: mm

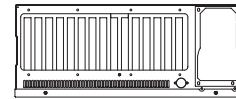

Rear view

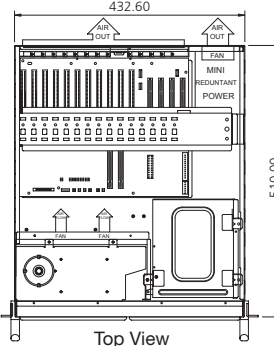

Top View

Right-side View

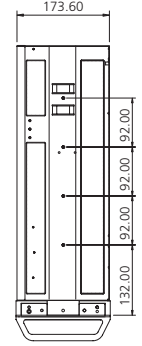

Front Inside View

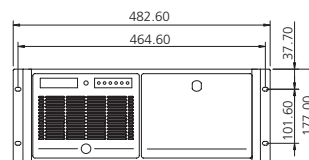

Front Outside View

Backplane Options

Model Name	PICMG® SBC	PCIe x1	PCIe x4	PCIe x16	PCI	ISA	PSU Connector
EBP-10E5	1	4	--	1	4	--	ATX
EBP-13E4	1	--	3	1	7	--	ATX
HPCI-15S	2	--	--	--	4	9	ATX/AT
HPCI-15S10	2	--	--	--	10	3	ATX/AT
HPCI-13S4LU	3	--	--	--	4	7	ATX/AT
HPCI-14S7U	3	--	--	--	7	5	ATX/AT
HPCI-14S12U	2	--	--	--	12	1	ATX/AT
HPCI-14S/ATX	2	--	--	--	4	8	ATX/AT

Mechanical Layout



RK-604A

Wallmount Compact Size Chassis with 4-slot Backplane for Half-size SBC



Features

- Ultra-compact wallmount IPC chassis for 4-slot backplane
- One front accessible 3.5" and one internal 3.5" drive bay
- Replaceable and easy-to-clean filter

Specifications

Dimensions	4.8 in x 10.2 in x 9.8 in (122 mm x 260 mm x 248 mm) (W x H x D)
Drive Bays	Two 3.5" drive bays (one front accessible and one internal)
Construction	SPCC+Zn Plate Heavy-Duty Steel
Color	Standard: beige
Cooling Fans	Two 42 CFM ball bearing fans (one for cards, one for HDD/PSU)
Front Panel	LEDs: HDD activity, system power
Backplane	4-slot passive backplane
Rear Pane	AT or ATX switch
Carton Size	14.1 in x 9.1 in x 14.6 in (358 mm x 232 mm x 370 mm)
Weight	Net 5.4 kg (11.9 lb)

Power Supply Options

Model Number	Watt	Input Range	Output (Max.)						Type
			+5V	+3.3V	+12V	-12V	-5V	+5Vsb	
APS-912XA	120 W	90 – 264 VAC Full Range	14 A	12 A	6 A	1 A	-	0.75 A	ATX

Ordering Information

Model Number	Color	Backplane	Power Supply
NS-604AW-PM4-12	Beige	HPM-4S	APS-912XA

Backplane Options

Model Name	PICMG® SBC	PCI	ISA	PSU Connector	Remark
HPM-4S	1	3	--	ATX	For half-size SBC

Mechanical Layout



Dimensions

Units: mm

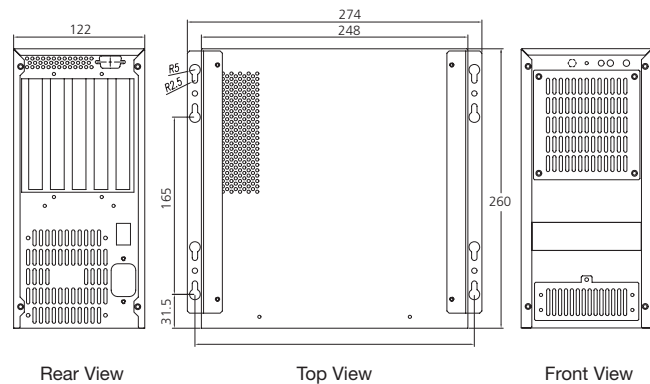

RK-606UC

Desktop/Wallmount Chassis with 6-slot Backplane for Full-Size SBC



Features

- Supports 6-slot PICMG® backplane
- Equipped with one 5.25" and one 3.5" front access drive bays
- Adjustable hold down bar for cards
- Replaceable and easy-to-clean filter

Specifications

Dimensions	7.5 in x 9.7 in x 16.2 in (190.5 mm x 246.4 mm x 411.5 mm) (W x H x D)
Drive Bays	One 5.25" and one 3.5" front accessible drive bay Two internal 3.5" drive bays
Construction	Heavy-duty cold-rolled steel
Color	Standard: black
Cooling Fans	One 8-cm in-take fan, 49 CFM
Front Panel	LEDs: HDD active and system power System reset switch, ATX Power switch, optional AT power on/off switch Two USB connectors
Backplane	6-slot passive backplane
Carton Size	20.9 in x 11.8 in x 15.4 in (530 mm x 300 mm x 390 mm)
Weight	Net 7 kg (15.4 lb)

Power Supply Options

Model Number	Watt	Input Range	Output (Max.)					Type	
			+5V	+3.3V	+12V	-12V	-5V		+5Vsb
APS-9130XU	300 W	90 – 264 VAC Full Range	24 A	20 A	20 A	0.5 A	0.5 A	1.5 A	ATX12V

Ordering Information

Model Number	Color	Backplane	Power Supply
NS-606UC-6S4-300	Black	HPCI-6S4	APS-9130XU

Backplane Options

Model Name	PICMG® SBC	PCI	ISA	PSU Connector
HPCI-6S4	1	4	1	ATX/AT

Mechanical Layout



Dimensions

Units: mm

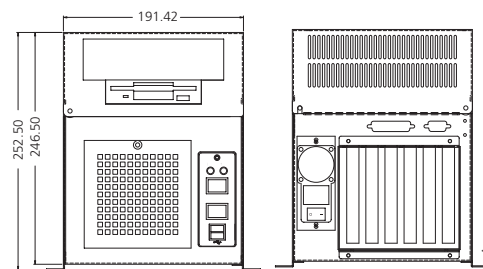
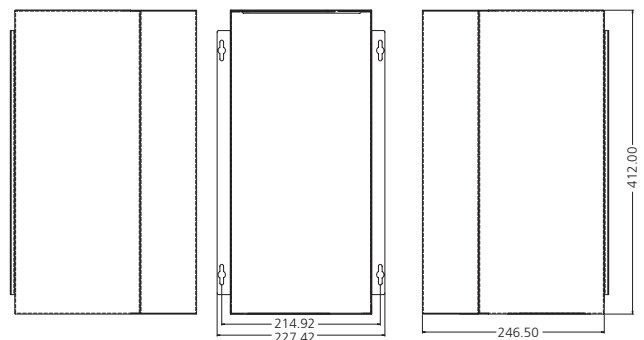

Front View

Rear View



Features

- Supports 6-slot PICMG backplane
- One 5.25" and one 3.5" external drive bay and one 3.5" internal drive bay
- Drive bay with shock and vibration resistant design
- Replaceable and easy-to-clean air filter
- 12cm cooling fan (85 CFM)
- Two USB and one PS/2 keyboard connectors on front panel

Specifications

Dimensions	10 in x 6.9 in x 16.5 in (254 mm x 175 mm x 419.1 mm) (W x H x D)
Drive Bays	One 5.25" and one 3.5" front accessible drive bays One internal 3.5" drive bay
Construction	Heavy-duty steel
Color	Standard: beige
Cooling Fans	In: one 120 mm x 120 mm x 25 mm ball bearing fan (85CFM)
Front Panel	LEDs: HDD active and system power System reset switch and ATX power switch Two USB and one PS/2 keyboard connectors
Backplane	6-slot passive backplane
Power Supply	PS2 form factor ATX power supply
Carton Size	21 in x 17.3 in x 12.4 in (533 mm x 440 mm x 315 mm)
Weight	Net 6.4 kg (14.1 lb)

Power Supply Options

Model Number	Watt	Input Range	Output (Max.)					Type	
			+5V	+3.3V	+12V	-12V	-5V		+5Vsb
APS-935XA-EPS12	350 W	90 – 264 VAC Full Range	35 A	28 A	26 A	0.8 A	0.5 A	2 A	EPS12V
APS-940XA-EPS12	400 W	90 – 264 VAC Full Range	35 A	28 A	30 A	0.8 A	0.5 A	2 A	EPS12V

Ordering Information

Model Number	Color	Backplane	Power Supply
NS-607B-6S4-350	Beige	HPCI-6S4	APS-935XA-EPS12

Dimensions

Units: mm

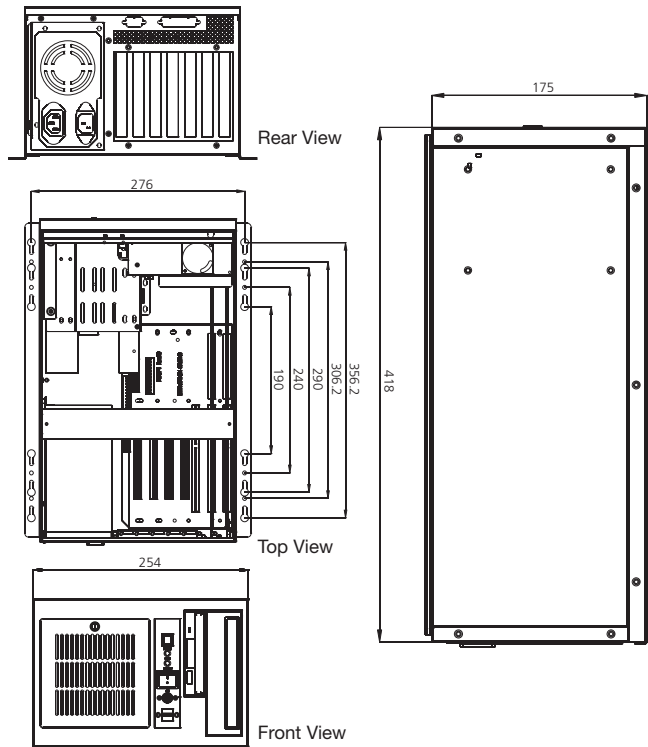

Backplane Options

Model Name	PICMG® SBC	PCIe x1	PCIe x4	PCIe x16	PCI	ISA	PSU Connector
EBP-5E1	1	--	--	1	--	--	ATX
HPCI-6S4	1	--	--	--	4	1	ATX/AT

Mechanical Layout



RK-608B

Wallmount Chassis for 10-slot Backplane



Features

- Supports 10 slot PICMG backplane
- Two 5.25" and two 3.5" external drive bays, one internal 3.5" drive bay
- Drive bay with shock and vibration resistant design
- Replaceable and easy-to-clean air filter
- 12cm cooling fan (85CFM)
- Two USB and one PS/2 keyboard connectors on front panel

Specifications

Dimensions	13 in x 6.9 in x 16.5 in (330 mm x 175 mm x 418 mm) (W x H x D)
Drive Bays	Two 5.25" and two 3.5" front accessible drive bays
Construction	Heavy-duty steel
Color	Standard: beige
Cooling Fans	In: one 120 mm x 120 mm x 25 mm ball bearing fan (85 CFM)
Front Panel	LEDs: HDD active and system power System reset switch and ATX power switch Two USB and one PS/2 keyboard connector
Backplane	10-slot passive backplane
Power Supply	PS2 form factor ATX power supply
Carton Size	20.9 in x 13.2 in x 18.1 in (530 mm x 335 mm x 460 mm)
Weight	Net 7.8 kg (17.2 lb)

Power Supply Options

Model Number	Watt	Input Range	Output (Max.)						Type
			+5V	+3.3V	+12V	-12V	-5V	+5Vsb	
APS-935XA-EPS12	350 W	90 – 264 VAC Full Range	35 A	28 A	26 A	0.8 A	0.5 A	2 A	EPS12V
APS-940XA-ATX12	400 W	90 – 264 VAC Full Range	35 A	28 A	30 A	0.8 A	0.5 A	2 A	ATX12V

Ordering Information

Model Number	Color	Backplane	Power Supply
NS-608B-9S7U-350	Beige	HPCI-9S7U	APS-935XA-EPS12

Backplane Options

Model Name	PICMG® SBC	PCIe x1	PCIe x4	PCIe x16	PCI	ISA	PSU Connector
HPCI-9S7U	2	--	--	--	7	1	ATX/AT

Mechanical Layout



Dimensions

Units: mm

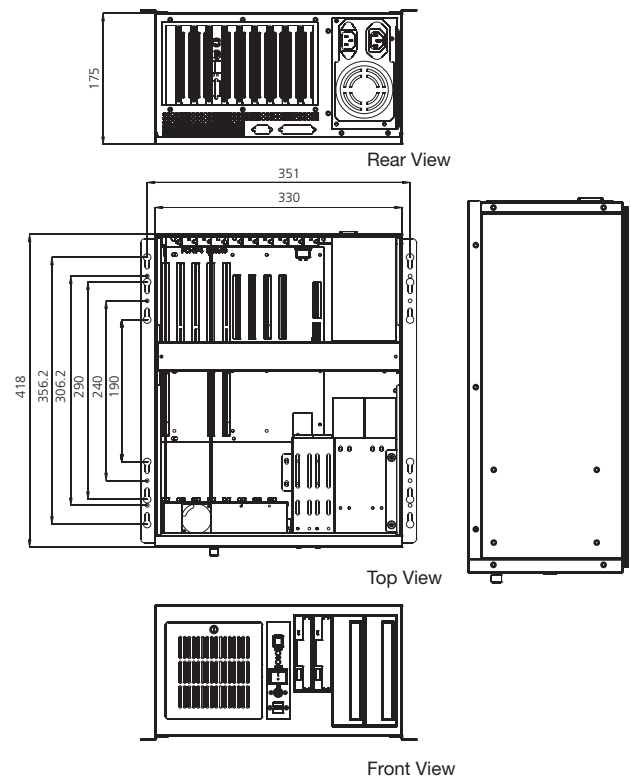

RK-608MB

Wallmount Chassis for ATX Industrial Motherboard



Features

- Supports Mini-ITX, microATX, FlexATX, ATX industrial motherboards
- One 5.25", two 3.5" external drive bays and three internal 3.5" drive bays
- Drive bay with shock and vibration resistant design
- Two USB and one PS/2 keyboard connectors on front panel
- 12cm cooling fan (85 CFM)
- PS2 ATX power supply

Specifications

Dimensions	13 in x 7.7 in x 16 in (330 mm x 196 mm x 406 mm) (W x H x D)
Drive Bays	One 5.25", two 3.5" external drive bays and three internal 3.5" drive bays
Construction	Heavy-duty steel
Color	Standard: Beige
Cooling Fans	In: one 120mm x 120mm x 25mm ball bearing fan (85 CFM)
Front Panel	LEDs: HDD active and system power System reset switch and ATX power switch Two USB and one PS/2 keyboard connectors
Backplane	Mini-ITX, microATX, FlexATX, or ATX industrial motherboard
Power Supply	PS2 form factor ATX power supply
Carton Size	20.9 in x 13.2 in x 18.1 in (530 mm x 335 mm x 460 mm)
Weight	Net 7.8 kg (17.2 lbs)

Ordering Information

Model Number	Color	Configurations / Power Supply
NS-608MB-350	Beige	APS-935XA-EPS12
NS-608MB-M302-64-00	Beige	M302, RK-608MB, Intel® Core™2 Duo E6400 2.13GHz, 2G RAM, 400W PSU
NS-608MB-M302-64-01	Beige	M302, RK-608MB, Intel® Core™2 Duo E6400 2.13GHz, 2G RAM, 400W PSU, Windows® XPP Embedded
NS-608MB-M302-44-00	Beige	M302, RK-608MB, Intel® Celeron® 440 2.0GHz, 1G RAM, 350W PSU
NS-608MB-M302-44-01	Beige	M302, RK-608MB, Intel® Celeron® 440 2.0GHz, 1G RAM, 350W PSU, Windows® XPP Embedded

The above listed models are equipped with HDD, DVD±R/RW
Contact your ADLINK representative for different CPU, memory combinations.

Mechanical Layout



Dimensions

Units: mm

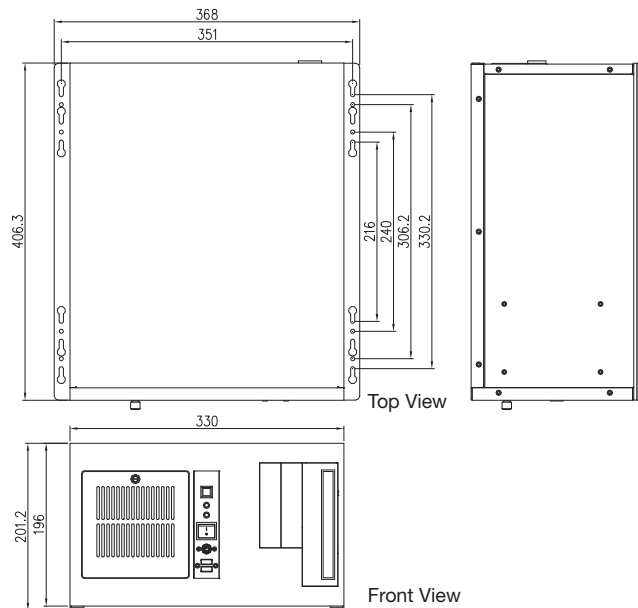

Backplane Selection Guide

Rackmount Chassis

PICMG 1.0	Slots per Segment			PCI-X	Compatible Chassis										
	PICMG	PCI	ISA		RK-110S	RK210S	RK-220	RK-260	RK-410FS	RK-440	RK-460	RK-610	RK-615FB		
HPCI-D3S2	1	2	-	-	✓										
HPCI-D6S4	1	4	1	-		✓	✓	✓							
HPCI-13S4LU	3	4	9	-					✓	✓	✓	✓	✓		
HPCI-14S7U	3	7	7	-					✓	✓	✓	✓	✓		
HPCI-14S12U	2	12	2	-					✓	✓	✓	✓	✓		
HPCI-14S/ATX	2	4	9	-					✓	✓	✓	✓	✓		
HPCI-15S	2	4	10	-						✓		✓	✓		
HPCI-15S10	2	10	4	-						✓		✓	✓		
HPCI-19S18A	2	18	1	-						✓					
PICMG 1.3	PICMG	PCI	PCI-E			PCI-X	RK-110SE	RK-210E	RK-220E						
			x1	x4	x16										
EBP-10E5	1	4	4		1	-					✓	✓	✓	✓	✓
EBP-13E2	1	10	-	1	1	-					✓	✓	✓	✓	✓
EBP-13E4	1	7	-	3	1	-					✓	✓	✓	✓	✓
EBP-D5E2	1	2	-	1	1	-		✓	✓						
EBP-D3S1	1	1	-			-	✓								
EBP-D3E1	1	-	-	1		-	✓								

Wallmount Chassis

PICMG 1.0	Slots per Segment			PCI-X	Compatible Chassis					
	PICMG	PCI	ISA		RK-604A	RK-606UC	RK-607B	RK-608B		
HPM-4S	1	3	-	-	✓					
HPM-5S	1	4	-	-		✓				
HPCI-6S4	1	4	1	-		✓	✓			
HPCI-8S4	2	4	4	-				✓		
HPCI-9S7U	2	7	2	-				✓		
PICMG 1.3	PICMG	PCI	PCI-E			PCI-X				
			x1	x4	x16					
EBP-7E2	1	4	-	1	1	-			✓	
EBP-9E2	1	6	-	1	1	-			✓	
EBP-5E1	1	2	-		1	1		✓	✓	✓

PICMG Backplanes

ADLINK offers a wide selection of standard PCI/ISA or PCI Express backplanes from 4 up to 20 slots. Our professional OEM team is capable of quick turnarounds for custom backplanes tailored to your specifications and chassis.

We make designing, developing, prototyping, and maintaining your projects simple and efficient. For all your backplane needs, contact us. We have a solution for you.

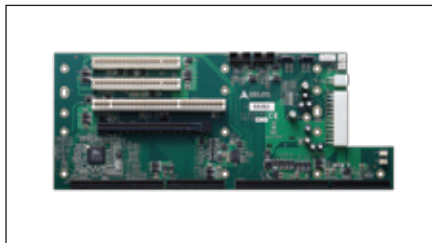
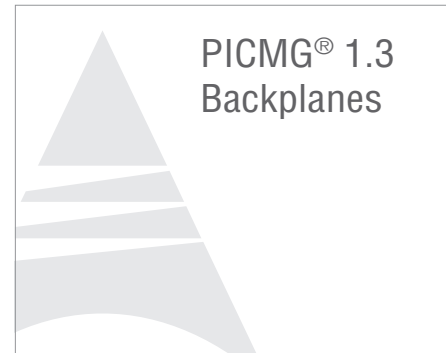

EBP-5E1			
PCI-E® x16	1	PICMG®	1
PCI-E® x4		AT	
PCI-X™	1	ATX	Yes
PCI™	2	Segments	1
Dimensions	153 mm x 330 mm		

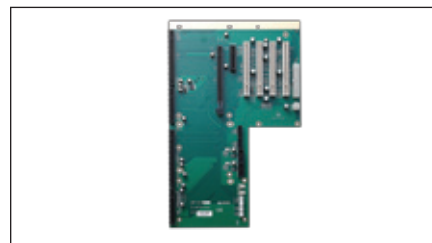

EBP-7E2			
PCI-E® x16	1	PICMG®	1
PCI-E® x4	1	AT	
PCI-E® x1		ATX	Yes
PCI™	4	Segments	1
Dimensions	328 mm x 206 mm		

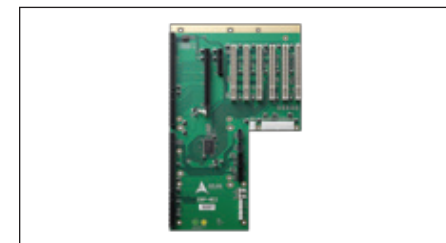

EBP-9E2			
PCI-E® x16	1	PICMG®	1
PCI-E® x4	1	AT	
PCI-E® x1		ATX	Yes
PCI™	6	Segments	1
Dimensions	328 mm x 206 mm		

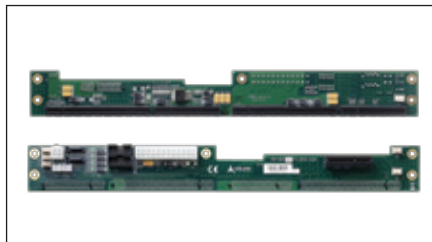

EBP-D3E1			
PCI-E® x16		PICMG®	1
PCI-E® x4	1	AT	
PCI-E® x1		ATX	Yes
PCI™		Segments	1
Dimensions	331 mm x 39 mm		

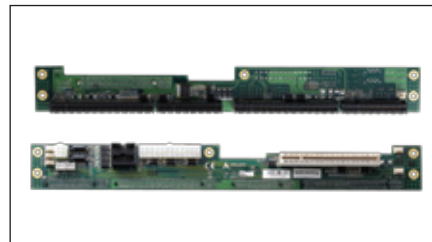

EBP-D3S1			
PCI-E® x16		PICMG®	1
PCI-E® x4		AT	
PCI-E® x1		ATX	Yes
PCI™	1	Segments	1
Dimensions	331 mm x 39 mm		

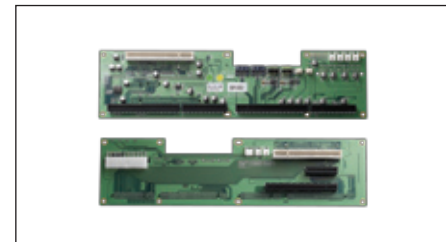

EBP-D5E2			
PCI-E® x16	1	PICMG®	1
PCI-E® x4	1	AT	
PCI-E® x1		ATX	Yes
PCI™	2	Segments	1
Dimensions	331 mm x 84 mm		

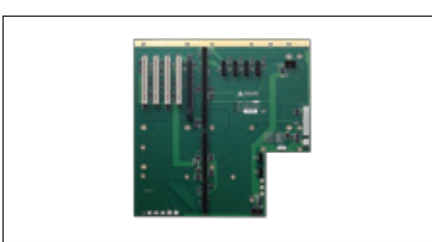

EBP-10E5			
PCI-E® x16	1	PICMG®	1
PCI-E® x4		AT	
PCI-E® x1	4	ATX	Yes
PCI™	4	Segments	1
Dimensions	330 mm x 318 mm		

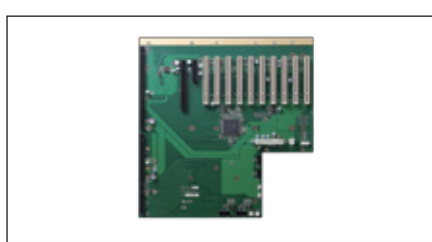

EBP-13E2			
PCI-E® x16	1	PICMG®	1
PCI-E® x4	1	AT	
PCI-E® x1		ATX	Yes
PCI™	10	Segments	1
Dimensions	330mm x 318mm		

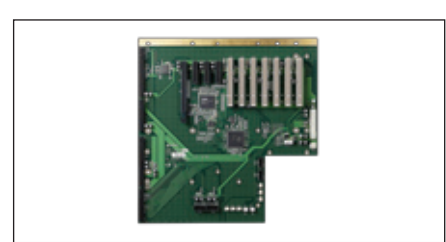

EBP-13E4			
PCI-E® x16	1	PICMG®	1
PCI-E® x4	3	AT	
PCI-E® x1		ATX	Yes
PCI™	7	Segments	1
Dimensions	330 mm x 318 mm		

PICMG® 1.0 Backplanes



HPCI-6S4

PICMG®	1	AT	Yes
PCI™	4	ATX	Yes
ISA	1	Segments	1
Dimensions	264.2 mm x 132.7 mm		

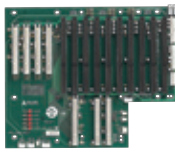

HPCI-13S4LU

PICMG®	3	AT	Yes
PCI™	4	ATX	Yes
ISA	9	Segments	1
Dimensions	314.7 mm x 259 mm		

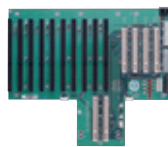

HPCI-14S/ATX

PICMG®	2	AT	Yes
PCI™	4	ATX	Yes
ISA	9	Segments	1
Dimensions	312 mm x 265 mm		



HPCI-19S18A

PICMG®	2	AT	Yes
PCI™	18	ATX	Yes
ISA	1	Segments	1
Dimensions	415.3 mm x 264.2 mm		

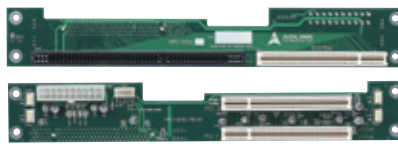

HPCI-D3S2

PICMG®	1	AT	
PCI™	2	ATX	Yes
ISA		Segments	1
Dimensions	261 mm x 39 mm		



HPCI-8S4

PICMG®	2	AT	Yes
PCI™	4	ATX	Yes
ISA	4	Segments	1
Dimensions	264.2 mm x 218 mm		

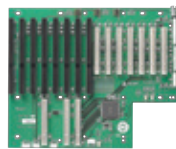

HPCI-14S7U

PICMG®	3	AT	Yes
PCI™	7	ATX	Yes
ISA	7	Segments	1
Dimensions	314.7 mm x 259.1 mm		



HPCI-15S

PICMG®	2	AT	Yes
PCI™	4	ATX	Yes
ISA	10	Segments	1
Dimensions	317 mm x 264.2 mm		



HPM-4S

PICMG®	1	AT	
PCI™	3	ATX	Yes
ISA		Segments	1
Dimensions	175 mm x 97.5 mm		

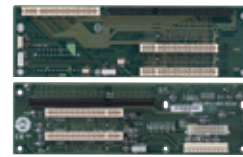

HPCI-D6S4

PICMG®	1	AT	Yes
PCI™	4	ATX	Yes
ISA	1	Segments	1
Dimensions	261 mm x 79.6 mm		



HPCI-9S7U

PICMG®	2	AT	Yes
PCI™	7	ATX	Yes
ISA	2	Segments	1
Dimensions	213.4 mm x 259.1 mm		

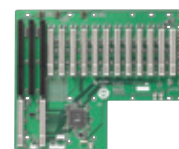

HPCI-14S12U

PICMG®	2	AT	Yes
PCI™	12	ATX	Yes
ISA	2	Segments	1
Dimensions	314.7 mm x 259 mm		

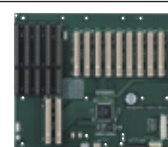

HPCI-15S10

PICMG®	2	AT	Yes
PCI™	10	ATX	Yes
ISA	4	Segments	1
Dimensions	317 mm x 264.2 mm		



HPM-5S

PICMG®	1	AT	
PCI™	4	ATX	Yes
ISA		Segments	1
Dimensions	175 mm x 133 mm		