

PICMG Bridged Backplane

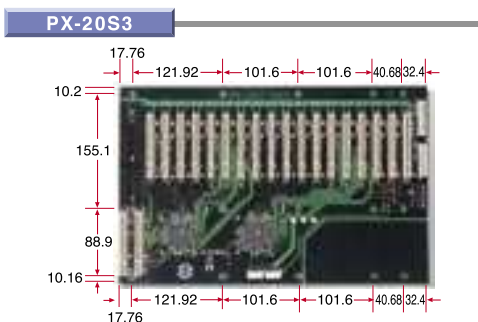

PCISA Backplane

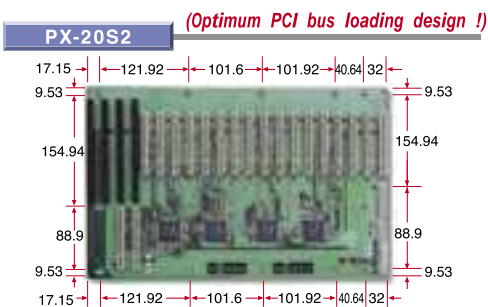
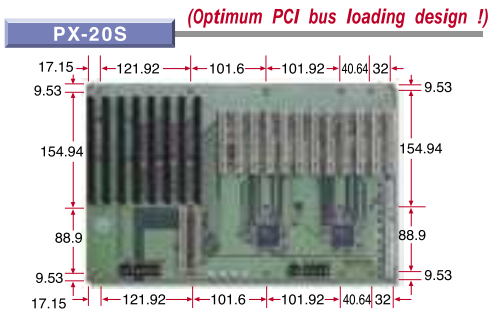
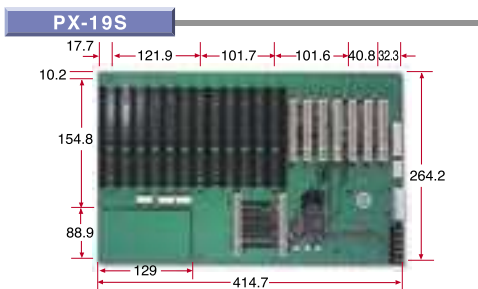
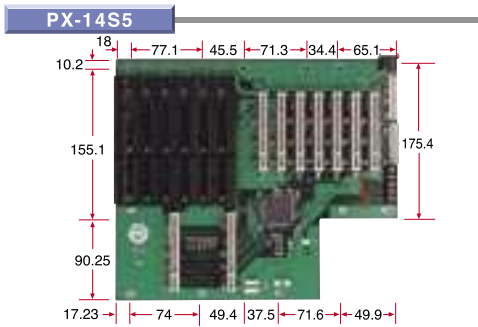
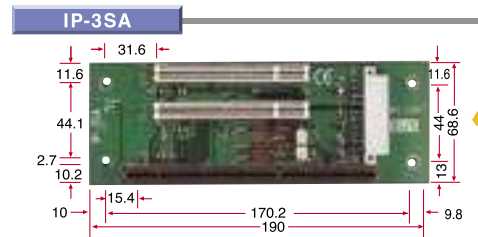
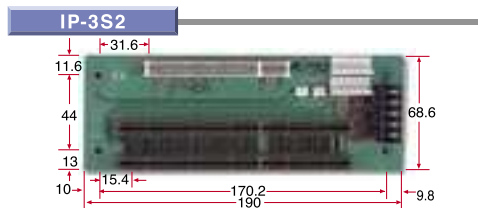
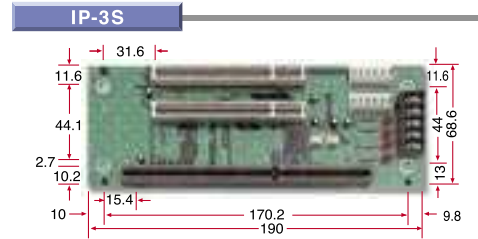

ATX Power Connector

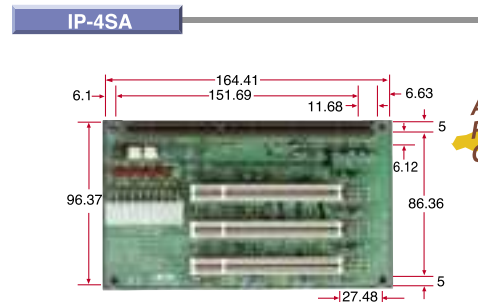
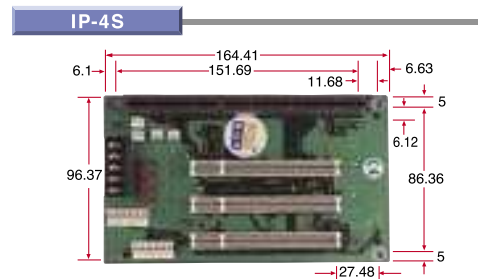
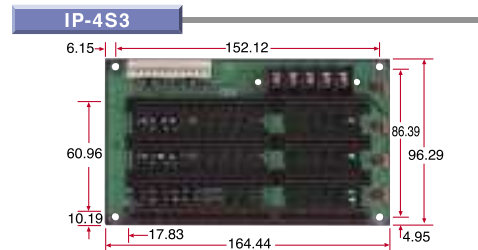

ATX Power Connector

Single Board Computer

- PIAGP Series
- PICMG
- Half-Size
- Industrial Motherboard
- 5.25" NOVA
- EPIC NANO
- 3.5" WAFER
- ETX
- PC/104
- Add-on Card
- IVC Card
- Backplane

LCD Product Series

Chassis

Power supply

Peripheral

PCISA Backplane

IP-4S2

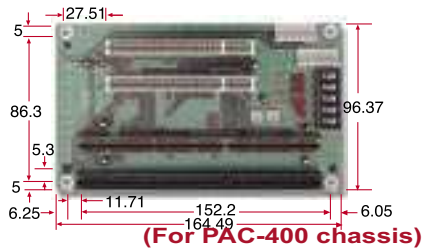

(For PAC-400 chassis)

ATX Power Connector

IP-5SA

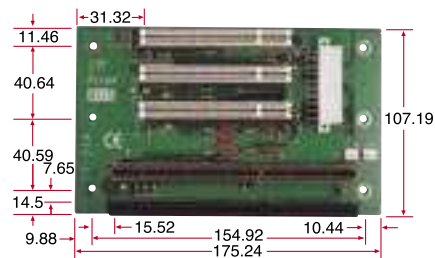

With 6W Audio amplifier

IP-4S2A

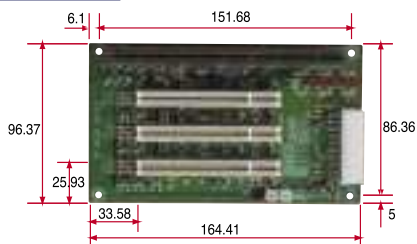

IP-5SA2

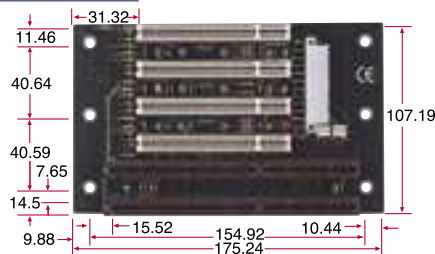

ATX Power Connector

IP-4S4

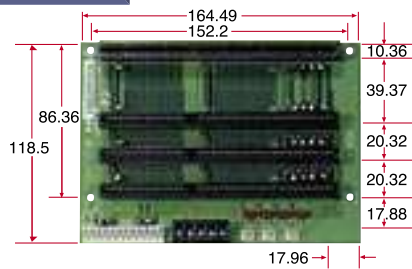

IP-6S

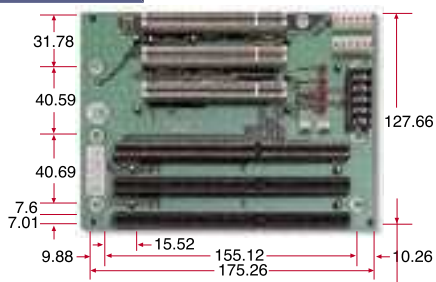

IP-5S

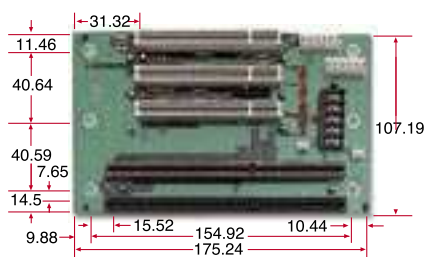

IP-6SA

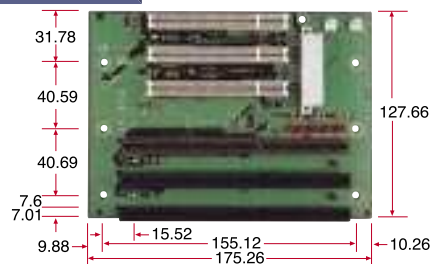

ATX Power Connector

IP-5S2

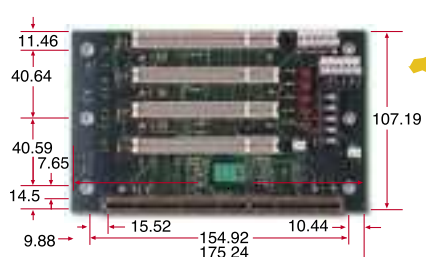

ATX Power Connector

IP-7S

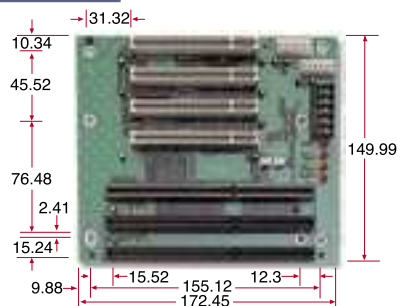

PCISA Backplane

IP-7SA

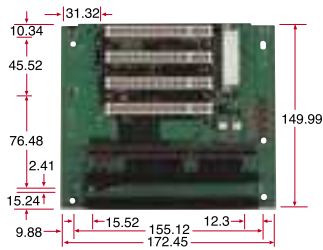

ATX Power Connector

IP-8S

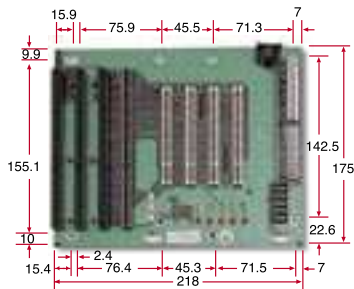

IP-10S

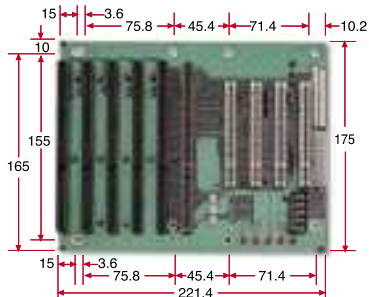

IP-10S2

(For RACK-900)

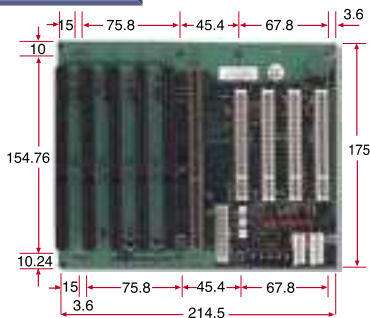

IP-12S

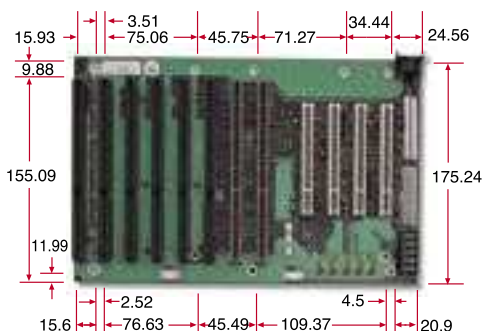

IP-13SD

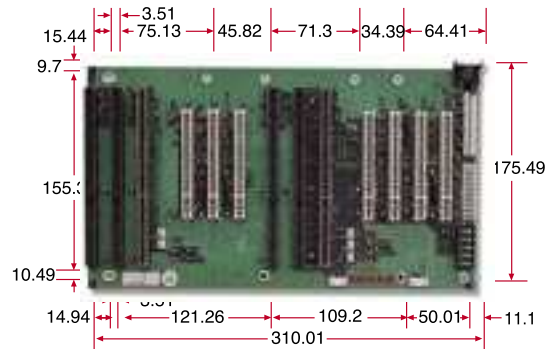

IP-14S

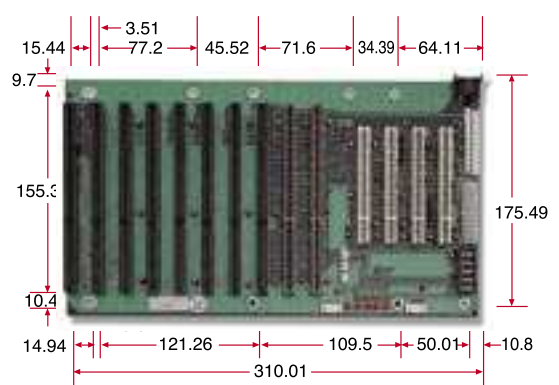

IP-14S3

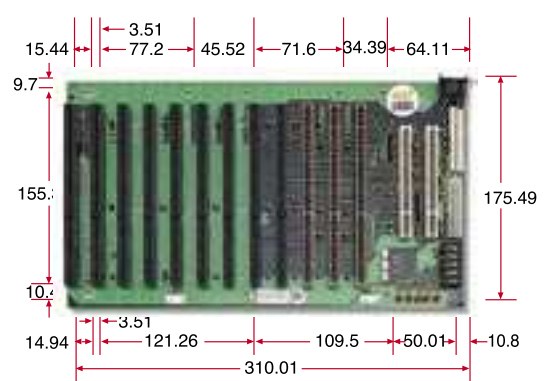

IP-18SD

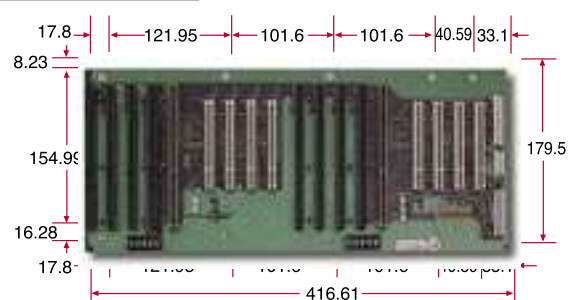

Single Board Computer

PIAGP Series
PICMG
Half-Size
Industrial Motherboard
5.25" NOVA
EPIC NANO
3.5" WAFER
ETX
PC/104
Add-on Card
IVC Card
Backplane

LCD Product Series

Chassis

Power supply

Peripheral